

▪BEMETA



stainless2025
publicSPACES2025

NEČEKANÉ KOUPELNOVÉ PŘÍBĚHY
UNEXPECTED BATHROOM STORIES
UNERWARTETE BADGESCHICHTEN



Dávkač mýdla

Soap dispensers / Seifenspender



4 - 11

**Zásobníky
papírových kapesníků**Tissue paper dispensers /
/ Seifenpapierspender

12 - 13

**Zásobníky
hygienických potřeb**Dispenser for hygiene products /
/ Spender für Hygieneprodukte

14 - 17

**Zásobníky
papírových ručníků**Paper towel dispenser /
/ Papierhandtuchspender

18 - 21

**Zásobníky
toaletního papíru**Toilet paper dispenser /
/ Papierrollenspender

22 - 23

**Držáky
toaletního papíru**Toilet paper holder /
/ Papierrollenhalter

24 - 27

WC štětkytoilet brush holder /
/ wc-bürstengarnitur

28 - 31

Odpadkové koše

Waste bin / Abfalleimer



32 - 37

**Bezdotykové
osoušeče rukou**Touchless hand dryers /
/ Händetrockner berührungslos

38 - 41

Zrcadla

Mirror / Spiegel



42 - 43

Odtokové žlaby

Shower drain / Duschrinne



44 - 47

Sprchový programShower accessories /
/ Duschzubehör

48 - 51

Bezbariérové bydleníBarrier-free living /
/ Barrierefreies wohnen

52 - 57

Poličky

Shelves / Ablagen



58 - 61

Fény

Hairdryers / Föhne



62 - 63

Kosmetická zrcátkaCosmetic mirrors /
/ Kosmetikspiegel

64 - 69

Doplňky

Accessories / Zubehör



70 - 73

Zařizovací předmětyFurnishing items /
/ Einrichtungsgegenstände

74 - 79

Zakázková výrobaCustom production /
/ Sonderanfertigung

80 - 81

Realizace na zakázkuRealisation to order /
/ Realisierung auf Bestellung

82

DÁVKOVAČE MÝDLA
SOAP DISPENSERS
SEIFENSPENDER





105109020 *černý/black/Schwarz*

105109024 *bílá/white/Weiss*

105109025 *mat/matt/Matt*

97×150×93 mm, 500 ml

Dávkovač mýdla

Soap dispenser

Seifenspender



105109034 *bílá/white/Weiss*

105109035 *mat/matt/Matt*

107×180×98 mm, 850 ml

Dávkovač mýdla

Soap dispenser

Seifenspender



105109410 *černý/black/Schwarz*

105109414 *bílá/white/Weiss*

105109411 *lesk/polished/Glänzend*

105109415 *mat/matt/Matt*

100×320×110 mm, 1100 ml

Dávkovač mýdla

Soap dispenser

Seifenspender



106109091 *lesk/polished/Glänzend*

100×150×105 mm, 500 ml

Dávkovač mýdla

Soap dispenser

Seifenspender



151109015

125×240×100, 350 ml

Dávkovač mýdla

Soap dispenser

Seifenspender



106109085

110×240×85 mm, 800 ml

Dávkovač mýdla

Soap dispenser

Seifenspender



105109075

125×210×110 mm, 1250 ml

Dávkovač mýdla

Soap dispenser
Seifenspender



105109205

180×180×105 mm, 1500 ml

Dávkovač mýdla

Soap dispenser
Seifenspender



101109285

100×335×195 mm, 1000 ml

Dávkovač mýdla

Soap dispenser
Seifenspender



137209155

70×175×120 mm, 250 ml

Automatický dávkovač mýdla

Automatic soap dispenser
Automatischer Seifenspender



141109195

102×220×110, 700 ml

Automatický dávkovač mýdla

Automatic soap dispenser
Automatischer Seifenspender



105109345

142×268×102 mm, 1100 ml

**Automatický dávkovač
pěnového mýdla**

Automatic foam soap dispenser
Automatischer Seifen/
Desinfektionsmittelspender



105109335

142×268×102 mm, 1100 ml

**Automatický dávkovač mýdla
nebo dezinfekčního gelu**

Automatic liquid soap/disinfectant
gel dispenser
Automatischer Seifen-
und Desinfektionsmittelspender



124109265

mýdlo/soap/Seife

124109335

dezinfekce/disinfectant/Desinfektion

140×235×102 mm, 1200 ml

Automatický dávkovač

Automatic soap dispenser
Automatischer Seifenspender



105109015

240×140×150 mm, 1100 ml

Integrovaný dávkovač mýdla

Integrated soap dispenser
Einbaseifenspender

**101109095**

66×235×120 mm, 500 ml

niva**163109090***černý / black / Schwarz***easy****163109091***lesk / polished / Poliert***easy**

66×235×120 mm, 500 ml

**163109220***černý / black / Schwarz***easy****163109221***lesk / polished / Poliert***easy**

66×165×120 mm, 300 ml

Dávkovač mýdla, samolepícíSoap dispenser, self-adhesive
Seifenspender, Selbstklebender**Dávkovač mýdla, samolepící**Soap dispenser, self-adhesive
Seifenspender, Selbstklebender**Dávkovač mýdla, samolepící**Soap dispenser, self-adhesive
Seifenspender, Selbstklebender**104109115**

75×145×100 mm, 200 ml

NEO**104109016**

80×190×133 mm, 230 ml

NEO**Dávkovač mýdla**Soap dispenser
Seifenspender**Dávkovač mýdla**Soap dispenser
Seifenspender**104109035**

70×230×110 mm, 550 ml

NEO**104109015**

55×175×85 mm, 150 ml

NEO**Dávkovač mýdla**Soap dispenser
Seifenspender**Dávkovač mýdla**Soap dispenser
Seifenspender



146109420 *černý/black/Schwarz*
146109421 *lesk/polished/Glänzend*
146109425 *mat/matt/Matt*
 90×175×70 mm, 500 ml

Držák pro dávkovač mýdla, kulatý

Holder for soap dispenser, round
 Halter für Seifenspender, rund



146109440 *černý/black/Schwarz*
146109441 *lesk/polished/Glänzend*
146109445 *mat/matt/Matt*
 227×175×70 mm, 3×500 ml

Trojitý držák pro dávkovač mýdla, kulatý

Triple holder for soap dispenser, round
 Dreifachhalter für Seifenspender, rund



146109450 *černý/black/Schwarz*
146109451 *lesk/polished/Glänzend*
146109455 *mat/matt/Matt*
 80×185×60 mm, 500 ml

Držák pro dávkovač mýdla, hranatý

Holder for soap dispenser, square
 Halter für Seifenspender, eckig



146109430 *černý/black/Schwarz*
146109431 *lesk/polished/Glänzend*
146109435 *mat/matt/Matt*
 150×175×70 mm, 2×500 ml

Dvojitý držák pro dávkovač mýdla, kulatý

Double holder for soap dispenser, round
 Doppelhalter für Seifenspender, rund



131567700 *bílá/white/Weiss*
131567701 *hnědá/brown/Braun*
131567702 *černá/black/Schwarz*
 75×205×75 mm, 500 ml

Láhve s pumpičkou pro dávkovač mýdla, kulaté

Bottle with pump for soap dispenser, round
 Flasche mit Pumpe für Seifenspender, runde



146109460 *černý/black/Schwarz*
146109461 *lesk/polished/Glänzend*
146109465 *mat/matt/Matt*
 132×185×55 mm, 2×500 ml

Dvojitý držák pro dávkovač mýdla, hranatý

Double holder for soap dispenser, square
 Doppelhalter für Seifenspender, eckig



146109470 *černý/black/Schwarz*
146109471 *lesk/polished/Glänzend*
146109475 *mat/matt/Matt*
 200×185×55 mm, 3×500 ml

Trojité držák pro dávkovač mýdla, hranatý

Triple holder for soap dispenser, square
 Dreifachhalter für Seifenspender, eckig



131567703 *bílá/white/Weiss*
131567704 *hnědá/brown/Braun*
131567705 *černá/black/Schwarz*
 68×220×50 mm, 500 ml

Láhve s pumpičkou pro dávkovač mýdla, hranaté

Bottle with pump for soap dispenser, square
 Flasche mit Pumpe für Seifenspender, eckig



124109347 *mýdlo/soap/Seife*
124109334 *dezinfekce/disinfectant/Desinfektion*
 140×235×107 mm, 1100 ml

Automatický dávkovač

Automatic soap dispenser
 Automatischer Seifenspender



101519020
 163×60×90 mm

LIVING

Dvojité držák pro dávkovač mýdla, hranatý

Double holder for soap dispenser, square
 Doppelhalter für Seifenspender, eckig

OSTATNÍ DÁVKOVAČE MÝDLA

Other soap dispenser / Andere Seifenspender



121209032
 135×275×120 mm, 1000 ml

Automatický dávkovač pěnového mýdla

Automatic foam soap dispenser
 Automatisch Schaumseifenspender



124109290 *mýdlo/soap/Seife*
124109330 *dezinfekce/disinfectant/Desinfektion*
 140×235×102 mm, 1200 ml

Automatický dávkovač

Automatic soap dispenser
 Automatischer Seifenspender



107109240

86×165×115 mm, 450 ml

Dávkovač mýdla

Soap dispenser
Seifenspender



107109256

86×160×105 mm, 450 ml

Dávkovač mýdla

Soap dispenser
Seifenspender



151109095

125×240×100 mm, 500 ml

Dávkovač mýdla

Soap dispenser
Seifenspender



121209144

65×185×75 mm, 300 ml

Dávkovač mýdla

Soap dispenser
Seifenspender



121209140

65×185×75 mm, 300 ml

Dávkovač mýdla

Soap dispenser
Seifenspender



124109346

300×1215×300 mm, 1100 ml

Automatický dávkovač dezinfekce se stojanem

Automatic disinfectant dispenser with stand
Automatischer Desinfektionsspender mit Ständer



124109355

350×1230×350 mm, 1200 ml

Automatický dávkovač dezinfekce se stojanem, nerez

Automatic disinfectant dispenser with stand, stainless steel
Automatischer Desinfektionsspender mit Ständer, Edelstahl

**121209030***mýdlo/soap/Seife***121209400***pěna/foam/Schaum*

115×245×110 mm, 1000 ml

Dávkovač

Dispenser

Spender

**121209142***lesk/polished/Glänzend***121209145***mat/matt/Matt*

65×185×75 mm, 300 ml

Dávkovač mýdla

Soap dispenser

Seifenspender

**136109012***lesk/polished/Glänzend***136109010***mat/matt/Matt*

62×287×125 mm, 470 ml

Integrovaný dávkovač mýdla, horní plnění

Integrated soap dispenser, top filling

Einbauseifenspender, Top-Füllung

**121109036***mýdlo/soap/Seife***121109406***pěna/foam/Schaum*

115×245×110 mm, 1000 ml

Dávkovač

Dispenser

Spender

**121209132***lesk/polished/Glänzend***121209135***mat/matt/Matt*

120×185×75 mm, 2×300 ml

Dávkovač mýdla dvojitý

Double soap dispenser

Doppelter Seifenspender

**152109142***lesk/polished/Glänzend***152109143***mat/matt/Matt*

48×340×120 mm, 1100 ml

Integrovaný dávkovač mýdla/saponátu, horní plnění

Integrated soap/detergent dispenser, top filling

Einbauspendler für Seife und Spülmittel, Top-Füllung

**121209037***mýdlo/soap/Seife***121209407***pěna/foam/Schaum*

115×245×110 mm, 1000 ml

Dávkovač

Dispenser

Spender

**168109017****169109017**

68×155×125 mm, 200 ml

**circum
quadra****Dávkovač mýdla**

Soap dispenser

Seifenspender

**152109122***lesk/polished/Glänzend***152109125***mat/matt/Matt*

55×270×125 mm, 300 ml

Integrovaný dávkovač mýdla/saponátu, horní plnění

Integrated soap/detergent dispenser, top filling

Einbauspendler für Seife und Spülmittel, Top-Füllung

ZÁSOBNÍKY PAPIROVÝCH KAPESNÍKŮ
TISSUE PAPER DISPENSERS
SEIFENPAPIERSPENDER



**102303020**

250×130×75 mm

Zásobník papírových kapesníkůPaper tissue dispenser
Papiertaschentuchspender**102303021**

250×130×75 mm

Zásobník papírových kapesníkůPaper tissue dispenser
Papiertaschentuchspender**102303025**

250×130×75 mm

Zásobník papírových kapesníkůPaper tissue dispenser
Papiertaschentuchspender**134203022**

200×120×110 mm

Integrovaný zásobník papírových kapesníkůIntegrated paper tissue dispenser
Einbau-Papiertuchspender**113103021**

300×160×60 mm

Integrovaný zásobník papírových kapesníkůIntegrated paper tissue dispenser
Einbau-Papiertuchspender**101003025**

273×123×78 mm

Zásobník papírových kapesníkůPaper tissue dispenser
Papiertaschentuchspender**OSTATNÍ ZÁSObNÍKY PApÍROVÝCH KAPESNÍKŮ**

Other tissue paper dispensers / Andere Seifenpapierspender

**102303022**

250×130×70 mm

Zásobník papírových kapesníkůPaper tissue dispenser
Papiertaschentuchspender**101303001**

267×72×137 mm

Zásobník papírových kapesníkůPaper tissue dispenser
Papiertaschentuchspender**101003021**

120×130×120 mm

105103071

125×130×130 mm

Zásobník papírových kapesníkůPaper tissue dispenser
Papiertaschentuchspender

**ZÁSOBNÍKY HYGIENICKÝCH POTŘEB
DISPENSER FOR HYGIENE PRODUCTS
SPENDER FÜR HYGIENEPRODUKTE**



**101403130***černý/black/Schwarz***101403131***lesk/polished/Glänzend***101403134***bílý/white/Weiss***101403135***mat/matt/Matt*

92×131×24 mm

Zásobník hygienických sáčků (HygBag)

Hygiene bags dispenser (HygBag)

HygBag

**101403091***lesk/polished/Glänzend***101403094***bílý/white/Weiss***101403095***mat/matt/Matt*

120×240×32 mm

Zásobník hygienických sáčků (HygBag)

Hygiene bags dispenser (HygBag)

HygBag

**101403031***lesk/polished/Glänzend***101403035***mat/matt/Matt*

100×140×25 mm

Zásobník hygienických sáčků (HygBag)

Hygiene bags dispenser (HygBag)

HygBag

**101403276***černý/black/Schwarz***101403278***bílý/white/Weiss***101403277***růžový/pink/Rosa***101403279***zelený/green/Grün***101403275***mat/matt/Matt*

220×226×95 mm

Zásobník na tampony a vložky

Tampon and pad dispenser

Spender für Tampons und Binden



101015295

230×300×115 mm, 6,5 l

**Odpadkový koš se zásobníkem
hygienických sáčků**

Waste bin with a dispenser for sanitary bags
and a plastic container

Hygieneabfallbehälter mit Bentelspender



101003215

252×138×88 mm

Zásobník hygienických rukavic

Disposable gloves dispenser

Handschuhspender

OSTATNÍ ZÁSObNÍKY HYGIENICKÝCH POTŘEB

Other dispenser for hygiene products / Andere Spender für Hygieneprodukte



101403032

100×135×25 mm

**Zásobník hygienických sáčků
(HygBag)**

Hygiene bags dispenser (HygBag)

HygBag



101403030

100×135×25 mm

**Zásobník hygienických sáčků
(HygBag)**

Hygiene bags dispenser (HygBag)

HygBag



121103126

435×285×50 mm

**Zásobník hygienických ochran
WC**

Dispenser for toilet hygiene protection

Papierauflegespender für WC-Sitz



**ZÁSOBNÍKY PAPIROVÝCH RUČNÍKŮ
PAPER TOWEL DISPENSERS
PAPIERHANDTUCHSPENDER**





113103030 *černý/black/Schwarz*

113103034 *bílá/white/Weiss*

113103031 *lesk/polished/Glänzend*

113103035 *mat/matt/Matt*

280×245×105 mm

Zásobník papírových ručníků

Paper towel dispenser

Papierhandtuchspender



113103040 *černý/black/Schwarz*

113103044 *bílá/white/Weiss*

113103041 *lesk/polished/Glänzend*

113103045 *mat/matt/Matt*

280×350×105 mm

Zásobník papírových ručníků

Paper towel dispenser

Papierhandtuchspender



101003205

384×336×115 mm, 1100 ml

Zásobník papírových ručníků s dávkovačem mýdla

Paper towel dispenser with soap dispenser

Papierhandtuchspender mit Seifenspender



101003045

265×192×120 mm

Zásobník papírových ručníků

Paper towel dispenser

Papierhandtuchspender



101003255

298×448×124 mm

Zásobník papírových ručníků

Paper towel dispenser

Papierhandtuchspender



101003245

298×448×124 mm

Zásobník papírových ručníků

Paper towel dispenser

Papierhandtuchspender



101003235
280×213×103 mm

Zásobník papírových ručníků

Paper towel dispenser
Papierhandtuchspender



101003275
280×360×103 mm

Zásobník papírových ručníků

Paper towel dispenser
Papierhandtuchspender



101503040
280×220×128 mm

Living

Zásobník papírových ručníků

Paper towel dispenser
Papierhandtuchspender

OSTATNÍ ZÁSObNÍKY PAPIROVÝCH RUČNÍKŮ

Other paper towel dispenser / Andere Papierhandtuchspender



121103106
260×380×160 mm

Zásobník na skládané papírové ručníky

V-folded paper towel dispenser
Tuchspender für V-gefaltetes Papier



121103014
260×315×105 mm

Zásobník papírových ručníků

Paper towel dispenser
Papierhandtuchspender



113103052 *lesk/polished/Glänzend*
113103055 *mat/matt/Matt*
310×1225×165 mm

Zásobník papírových ručníků s odpadkovým košem

Paper towel dispenser with waste bin
Papiertuchspenderschrank mit Abfalleimer



ZÁSOBNÍKY TOALETNÍHO PAPIÍRU
TOILET PAPER DISPENSERS
PAPIERROLLENSPENDER





148112050 *černý/black/Schwarz*
148112054 *bílá/white/Weiss*
148112051 *lesk/polished/Glänzend*
148112055 *mat/matt/Matt*
 200×200×130 mm

Bubnový zásobník toaletního papíru

Jumbo-roll toilet paper dispenser
 JUMBO Papierrollenspender



101003225
 173×78×145 mm

Zásobník na vlhčený toaletní papír

Dispenser for wet toilet paper
 Feuchtes Toilettenpapierspender



148212050 *černý/black/Schwarz*
148212051 *lesk/polished/Glänzend*
148212055 *mat/matt/Matt*
 260×282×127 mm

Bubnový zásobník toaletního papíru, nerez

Jumbo-roll toilet paper dispenser, stainless steel
 JUMBO Papierrollenspender, Edelstahl

OSTATNÍ ZÁSObNÍKY TOALETNÍHO PAPÍRU

Other toilet paper dispenser / Andere Papierrollenspender



121112056
 270×285×130 mm

Zásobník toaletního papíru

Jumbo-roll toilet paper dispenser
 JUMBO Papierrollenspender



124112056
 287×290×120 mm

Zásobník toaletního papíru

Jumbo-roll toilet paper dispenser
 JUMBO Papierrollenspender



148312080 *černý/black/Schwarz*
148312081 *lesk/polished/Glänzend*
148312085 *mat/matt/Matt*
 310×325×128 mm

Bubnový zásobník toaletního papíru, nerez

Jumbo-roll toilet paper dispenser, stainless steel
 JUMBO Papierrollenspender, Edelstahl

DRŽÁKY TOALETNÍHO PAPIÍRU
TOILET PAPER HOLDERS
PAPIERROLLENHALTER





104112200 *černá/black/Schwarz*
104112201 *lesk/polished/Glänzend*
104112205 *mat/matt/Matt*
 125×260×125 mm

Držák toaletního papíru dvojitý

Double toilet paper holder
 Doppelter Toilettenpapierhalter



101012185
 243×111×90 mm

Držák toaletního papíru dvojitý

Double toilet paper holder
 Doppelter Toilettenpapierhalter



101012015
 143×111×90 mm

Držák toaletního papíru

Toilet paper holder
 Toilettenpapierhalter



101012175
 205×135×147 mm

Držák toaletního papíru se skříňkou

Toilet paper holder with box
 Toilettenpapierhalter mit Schachtel



101012045
 254×53×67 mm

Držák toaletního papíru dvojitý

Double toilet paper holder
 Doppelter Toilettenpapierhalter



105112315
 140×80×100 mm

Držák toaletního papíru s krytem

Toilet paper holder with cover
 Toilettenpapierhalter mit Deckel



146212011
 133×67×105 mm

Držák toaletního papíru s krytem a policičkou

Toilet paper holder with cover and shelf
 Toilettenpapierhalter mit Handy-Regal



153312132
 180×77×93 mm

Držák toaletního papíru s policičkou

Toilet paper holder with shelf
 Toilettenpapierhalter mit Ablage



134103012
 200×60×100 mm

Integrovaný držák toaletního papíru

Integrated toilet paper holder
 Einbaut Toilettenpapierhalter



104212035
104212035L

175×55×70 mm

NEO
NEO

Držák toaletního papíru

Toilet paper holder
Toilettenpapierhalter

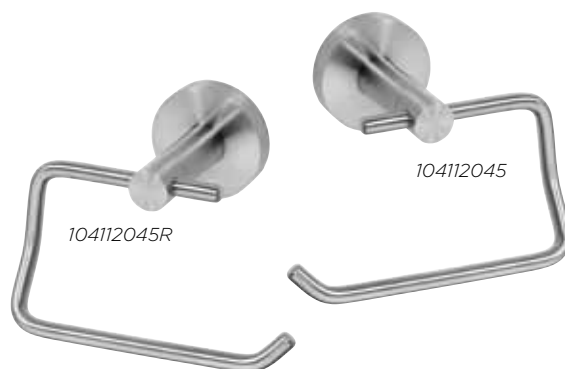

104112045R
104112045

135×120×98 mm

NEO
NEO

Držák toaletního papíru bez krytu

Toilet paper holder without cover
Toilettenpapierhalter ohne Deckel



104112015
137×143×90 mm

NEO

Držák toaletního papíru s krytem

Toilet paper holder with cover
Toilettenpapierhalter mit Deckel



104112035
55×165×65 mm

NEO

Držák toaletního papíru rezervní

Spare toilet paper holder
Reservetoilettenpapierhalter



146212245
320×30×90 mm

NEO

Držák toaletního papíru dvojitý

Double toilet paper holder
Doppelter Toilettenpapierhalter



101104015
270×57×80 mm

niva

Držák toaletního papíru s poličkou, samolepící

Toilet paper holder with shelf, self-adhesive
Toilettenpapierhalter mit Ablage, Selbstklebender



101106025
155×57×80 mm

niva

Držák toaletního papíru, samolepící

Toilet paper holder, self-adhesive
Toilettenpapierhalter, Selbstklebender



101012150 *černá/black/Schwarz*
101012154 *bílá/white/Weiss*
 160×100×86 mm

Držák toaletního papíru s poličkou

Toilet paper holder with shelf
 Toilettenpapierhalter mit Ablage



101512030
 126×190×133 mm

Držák toaletního papíru rezervní

Spare toilet paper holder
 Reservetoilettenpapierhalter

Living



101512230
 126×120×133 mm

Držák toaletního papíru

Toilet paper holder
 Toilettenpapierhalter

Living

OSTATNÍ DRŽÁKY TOALETNÍHO PAPIŘU

Other toilet paper holder / Andere papierrollenhalter



168212032 **circum**
169212032 **quadra**
 170×52×80 mm

Držák toaletního papíru

Toilet paper holder
 Toilettenpapierhalter



168212032L **circum**
169212032L **quadra**
 170×52×80 mm

Držák toaletního papíru

Toilet paper holder
 Toilettenpapierhalter



168112032 **circum**
169112032 **quadra**
 52×170×80 mm

Držák toaletního papíru rezervní

Spare toilet paper holder
 Reservetoilettenpapierhalter



168112042 **circum**
169112042 **quadra**
 137×110×55 mm

Držák toaletního papíru bez krytu

Toilet paper holder without cover
 Toilettenpapierhalter ohne Deckel



168112012 **circum**
169112012 **quadra**
 137×140×55 mm

Držák toaletního papíru s krytem

Toilet paper holder with cover
 Toilettenpapierhalter mit Deckel

WC ŠTĚTKY
TOILET BRUSH HOLDERS
WC-BÜRSTENGARNITUR



**101013175**

148×448×129 mm

Box na WC štětkuToilet brush box
WC-Bürstenkasten**101113335**

110×400×115 mm

WC štětka na pověšeníWall mounted toilet brush holder
WC-Bürstengarnitur hängend**101113091**

115×370×110 mm

WC štětka na pověšení, samolepícíWall mounted toilet brush holder, self-adhesive
WC-Bürstengarnitur hängend, Selbstklebender**niva****164113060****164113061****164113065**

105×355×97 mm

easy01**easy01****easy01**černý | black | Schwarz
lesk | polished | Poliert
mat | matt | Matt**163113060****163113061****163113065**

80×355×97 mm

easy**easy****easy**černý | black | Schwarz
lesk | polished | Poliert
mat | matt | Matt**WC štětka na pověšení**Wall mounted toilet brush holder
WC-Bürstengarnitur hängend**WC štětka na pověšení, samolepící**Wall mounted toilet brush holder, self-adhesive
WC-Bürstengarnitur hängend, Selbstklebender



104113105*
104113109**

110×400×130 mm

NEO
NEO

WC štětka na postavení

Toilet brush holder, free standing
WC-Bürstengarnitur freistehend



104113015*
104113019**

110×350×140 mm

NEO
NEO

WC štětka na pověšení

Wall mounted toilet brush holder
WC-Bürstengarnitur hängend



102313075*
102313079**

90×380×115 mm

NEO
NEO

WC štětka na postavení

Toilet brush holder, free standing
WC-Bürstengarnitur freistehend



102313069*
102313065**

90×380×105 mm

NEO
NEO

WC štětka na postavení/pověšení

Toilet brush holder, free standing/wall mounted
WC-Bürstengarnitur freistehend/hängend



102313055*
102313059**

95×380×95 mm

NEO
NEO

WC štětka na postavení

Wall mounted toilet brush holder
WC-Bürstengarnitur hängend



104913120

90×365×100 mm

DARK

WC štětka na pověšení

Wall mounted toilet brush holder
WC-Bürstengarnitur hängend

*bílý kartáč / white brush / weisse Bürste

**černý kartáč / black brush / schwarze Bürste

**101513180****LIVING**

123×360×106 mm

WC štětka na pověšení

Wall mounted toilet brush holder

WC-Bürstengarnitur hängend

OSTATNÍ WC ŠTĚTKY

Other toilet brush holder / Andere WC-Bürstengarnitur

**168113012****circum
quadra****169113012**

113×360×130 mm

WC štětka na pověšení

Wall mounted toilet brush holder

WC-Bürstengarnitur hängend



ODPADKOVÉ KOŠE
WASTE BINS
ABFALLEIMER





10191511 *lesk/polished/Glänzend*
10191515 *mat/matt/Matt*
10191510 *černý/black/Schwarz*
 250×500×250 mm, 25 l

101915121 *lesk/polished/Glänzend*
101915125 *mat/matt/Matt*
 300×600×250 mm, 45 l

101915131 *lesk/polished/Glänzend*
101915135 *mat/matt/Matt*
 300×600×400 mm, 72 l

Odpadkový koš na postavení/pověšení

Waste bin, free standing/wall mounted
 Abfalleimer freistehend/hängend



126115390 *zlatý/gold/Gold*
126115393 *růžové zlatý/rose gold/Roségold*
126115395 *mat | matt | Matt*
126115398 *černý/black/Schwarz*
 225×305×165 mm, 6 l

Odpadkový koš

Waste bin
 Abfalleimer



105115054 *bílý/white/Weiss*
105115055 *mat/matt/Matt*
 190×265×90 mm, 5 l

Odpadkový koš závěsný

Waste bin, wall mounted
 Abfalleimer hängend



125115041 *lesk/polished/Glänzend*
125115045 *mat/matt/Matt*
 370×460×165 mm, 25 l

Odpadkový koš na postavení/pověšení

Waste bin, free standing/wall mounted
 Abfalleimer freistehend/hängend



115115031 *lesk/polished/Glänzend*
115115035 *mat/matt/Matt*
 200×270×200 mm, 9 l

Odpadkový koš

Waste bin
 Abfalleimer

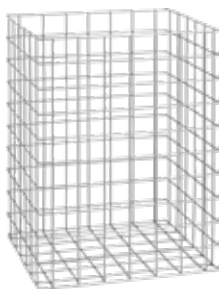

101015065

353×503×305 mm

Drátěný koš

Wired waste bin
Drahtkorb



101015355

300×600×330 mm

Kontejner s drátěným košem

Wired waste bin in receptacle
Behälter mit brachtkorb

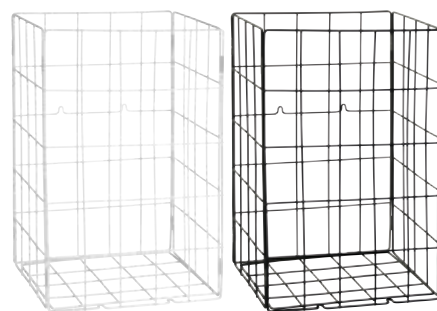

153115064

bílý/white/Weiss

153115060

černý/black/Schwarz

350×550×265 mm

Drátěný koš

Wired waste bin
Drahtkorb



101015365

455×603×255 mm

Drátěný koš s pevnou přední stranou závěsný

Hanging wired waste bin with fixed front
Drahtkorb mit festem Vorderwand zum Aufhängen



101015305

298×448×170 mm, 21 l

Odpadkový koš

Waste bin
Abfalleimer



101015295

230×300×115 mm, 6,5 l

Odpadkový koš se zásobníkem hygienických sáčků

Waste bin with a dispenser for sanitary bags and a plastic container
Hygieneabfallbehälter mit Bentelspender



125115051

lesk/polished/Glänzend

125115055

mat/matt/Matt

170×235×240 mm, 3 l

Odpadkový koš závěsný

Wall mounted waste bin
Wand-Abfalleimer



137115205

120×155×120 mm, 1,5 l

Odpadkový koš

Waste bin
Abfalleimer



150115151 *černý/black/Schwarz*

150115161 *mat/matt/Matt*

250×295×250 mm, 7,5 l

Odpadkový koš

Waste bin
Abfalleimer



125115071

200×300×200 mm, 6 l

Odpadkový koš

Waste bin
Abfalleimer



104315022 *lesk/polished/Glänzend*

104315025 *mat/matt/Matt*

170×255×170 mm, 3 l

104315012 *lesk/polished/Glänzend*

104315052 *mat/matt/Matt*

200×280×200 mm, 5 l

104315032 *lesk/polished/Glänzend*

250×390×250 mm, 12 l

104315082 *lesk/polished/Glänzend*

300×450×300 mm, 20 l

104315092 *lesk/polished/Glänzend*

300×650×300 mm, 30 l

104315102 *lesk/polished/Glänzend*

350×650×350 mm, 40 l



126115380 *černý/black/Schwarz*

126115385 *mat/matt/Matt*

250×315×250 mm, 15 l

Odpadkový koš na tříděný odpad

Waste sorting bin
Abfalleimer



126115370 *černý/black/Schwarz*

126115375 *mat/matt/Matt*

250×315×250 mm, 15 l

Odpadkový koš na tříděný odpad

Waste sorting bin
Abfalleimer

Odpadkový koš

Waste bin
Abfalleimer



137115165

400×490×320 mm, 2×15 l

Odpadkový koš na tříděný odpad

Waste sorting bin
Abfalleimer



104315262

590×435×375 mm, 3×14 l

Odpadkový koš na tříděný odpad

Waste sorting bin
Abfalleimer



104315272

590×435×375 mm, 2×20 l

Odpadkový koš na tříděný odpad

Waste sorting bin
Abfalleimer



101915051 *lesk/polished/Glänzend*

101915054 *bílý/white/Weiss*

101915055 *mat/matt/Matt*

101915050 *černý/black/Schwarz*

205×300×100 mm, 6 l

Odpadkový koš závěsný

Waste bin, wall mounted

Abfalleimer hängend



104315014 *bílý/white/Weiss*

104315010 *černý/black/Schwarz*

205×280×205 mm, 5 l

Odpadkový koš

Waste bin

Abfalleimer

**WHITE
DARK**

104315023
170×260×170 mm, 3 l

retro

Odpadkový koš

Waste bin

Abfalleimer



101015335

300×105×30 mm

Vhoz hranatý k zabudování do desky

Countertop-mounted lid trash bin cover

Quadratischer Abfallschacht zum Einbau



101015345

226×570×130 mm

Odpadkový koš s odkládací policí k zabudování

Recessed waste bin with storage shelf

Einbau-Abfallbehälter mit Ablagefläche



101015315

170×42×170 mm

Vhoz kulatý k zabudování do desky

Countertop-mounted circular waste chute

Durchwurfring zum Einbau

OSTATNÍ ODPADKOVÉ KOŠE

Other waste bin / Andere Abfalleimer



106101015

100×120×35 mm

Popelník

Ashtray

Aschenbecher



137115225

240×340×240 mm, 9 l

Odpadkový koš

Waste bin

Abfalleimer



137115215

450×755×430 mm, 90 l

Odpadkový koš

Waste bin

Abfalleimer



101015150

298×800×298 mm

Popelník venkovní

Ashtray

Aschenbecher freistehend für Aussenbereich

BEZDOTYKOVÉ OSOUŠEČE RUKOU
TOUCHLESS HAND DRYERS
HÄNDETROCKNER BERÜHRUNGSLOS





924224110 *černý/black/Schwarz*
924224111 *lesk/polished/Glänzend*
924224115 *mat/matt/Matt*
 290×325×105 mm, 1000 W

Bezdotykový osoušeč rukou, HEPA filtr

Automatic hand dryer, HEPA filter
 Automatischer Händetrockner mit HEPA-Filter



924224130 *černý/black/Schwarz*
924224131 *lesk/polished/Glänzend*
924224135 *mat/matt/Matt*
 173×255×150 mm, 1350 W

Bezdotykový osoušeč rukou

Automatic hand dryer
 Automatischer Händetrockner



924224120 *černý/black/Schwarz*
924224121 *lesk/polished/Glänzend*
924224125 *mat/matt/Matt*
 295×320×162 mm, 1800 W

Bezdotykový osoušeč rukou

Automatic hand dryer
 Automatischer Händetrockner



924224140 *černý/black/Schwarz*
924224141 *lesk/polished/Glänzend*
924224145 *mat/matt/Matt*
 260×230×205 mm, 2300 W

Bezdotykový osoušeč rukou

Automatic hand dryer
 Automatischer Händetrockner



924224150 *černý/black/Schwarz*
924224155 *mat/matt/Matt*
 170×255×100 mm, 700 W

Bezdotykový osoušeč rukou

Automatic hand dryer
 Automatischer Händetrockner



945224061 *lesk/polished/Glänzend*
106224015 *mat/matt/Matt*
 270×240×200 mm, 2500 W

Bezdotykový osoušeč rukou

Automatic hand dryer
 Automatischer Händetrockner

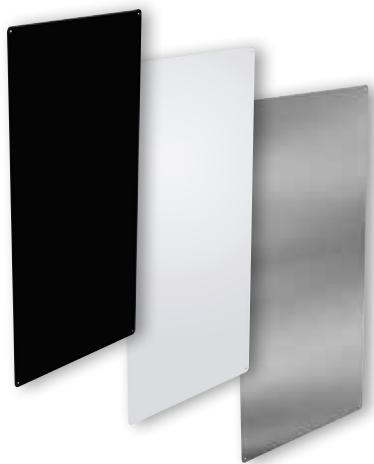

101044050 *černý/black/Schwarz*
101044055 *lesk/polished/Glänzend*
101044065 *mat/matt/Matt*
400×800×1 mm

**Ochranná deska proti stříkající vodě
pro osoušeče rukou**

Splash guard for hand dryer
Spritzschutz für Händetrockner

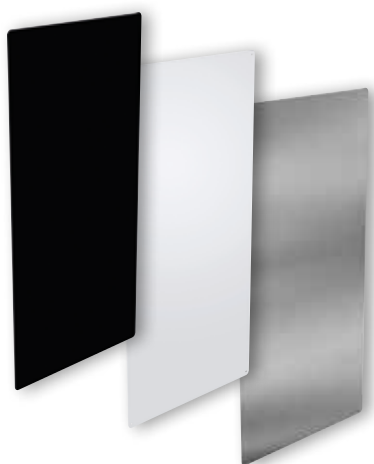

101043050 *černý/black/Schwarz*
101043055 *lesk/polished/Glänzend*
101043065 *mat/matt/Matt*
400×800×1 mm

**Ochranná deska proti stříkající vodě
pro osoušeče rukou k nalepení**

Splash guard for hand dryer for sticking
Spritzschutz für Händetrockner zum Kleben

**OSTATNÍ BEZDOTYKOVÉ
OSOUŠEČE RUKOU**

Other touchless hand dryers / Andere Händetrockner Berührungslos



945224016
240×240×230 mm, 1800 W

Bezdotykový osoušeč rukou
Automatic hand dryer
Automatischer Händetrockner



924224104
298×669×184 mm, 1850 W

**Bezdotykový osoušeč rukou,
HEPA filtr**
Automatic hand dryer, HEPA filter
Automatischer Händetrockner mit HEPA-Filter



zrcadLa
Mirrors
Spiegel





301401030 *černý/black/Schwarz*

301401031 *lesk/polished/Glänzend*

301401032 *mat/matt/Matt*

301401034 *bílý/white/Weiss*

400×600×120 mm

Výklopné zrcadlo

Tilting mirror

Kippspiegel



301401041 *lesk/polished/Glänzend*

301401042 *mat/matt/Matt*

301401044 *bílý/white/Weiss*

600×600×120 mm

Výklopné zrcadlo

Tilting mirror

Kippspiegel



101301652

600×800×5 mm

Zrcadlo na lepení

Mirror for gluing

Klebespiegel



301201041 *lesk/polished/Glänzend*

301201045 *mat/matt/Matt*

301201044 *bílý/white/Weiss*

301201040 *černý/black/Schwarz*

600×600×120 mm, 4,99 W

Výklopné zrcadlo s LED osvětlením

Tilting mirror for disabled people with LED lighting

Kippspiegel mit LED Beleuchtung



301201031 *lesk/polished/Glänzend*

301201035 *mat/matt/Matt*

301201034 *bílý/white/Weiss*

301201030 *černý/black/Schwarz*

400×600×120 mm, 4,99 W

Výklopné zrcadlo s LED osvětlením

Tilting mirror for disabled people with LED lighting

Kippspiegel mit LED Beleuchtung



101003265

400×455×140 mm, 1100 ml

Zrcadlová skříňka se zásobníkem papírových ručníků a dávkovačem mýdla

Mirror cabinet with a dispenser for paper towels and liquid soap

Spiegelschrank mit Papiertuch-u. Seifenspender



Kompatibilní s modely vyrobenými od 06/2025.
Compatible with models produced from 06/2025.
Kompatibel mit Modellen, die ab 06/2025 hergestellt wurden.

301501091 *lesk/polished/Glänzend*

301501095 *mat/matt/Matt*

301501094 *bílý/white/Weiss*

301501090 *černý/black/Schwarz*

109×148 mm, Ø 10 mm

Manipulační páčka k výklopným zrcadlům

30140103X, 30140104X, 30120103X, 3010104X

Handle for folding mirrors 30140103X, 30140104X, 30120103X, 3010104X

Griff zum Anklappen der Spiegel 30140103X, 30140104X, 30120103X, 3010104X

SPRCHOVÉ ODTOKOVÉ ŽLABY
SHOWER DRAINS
DUSCHRINNE





254653061

L = 1000 mm

254653031

L = 700 mm

254653051

L = 900 mm

254653021

L = 600 mm

254653041

L = 800 mm

254653011

L = 500 mm



Odtokový žlab PLUS, nerez

Shower drain PLUS, stainless steel

Duschrinne mit Rost PLUS, Edelstahl

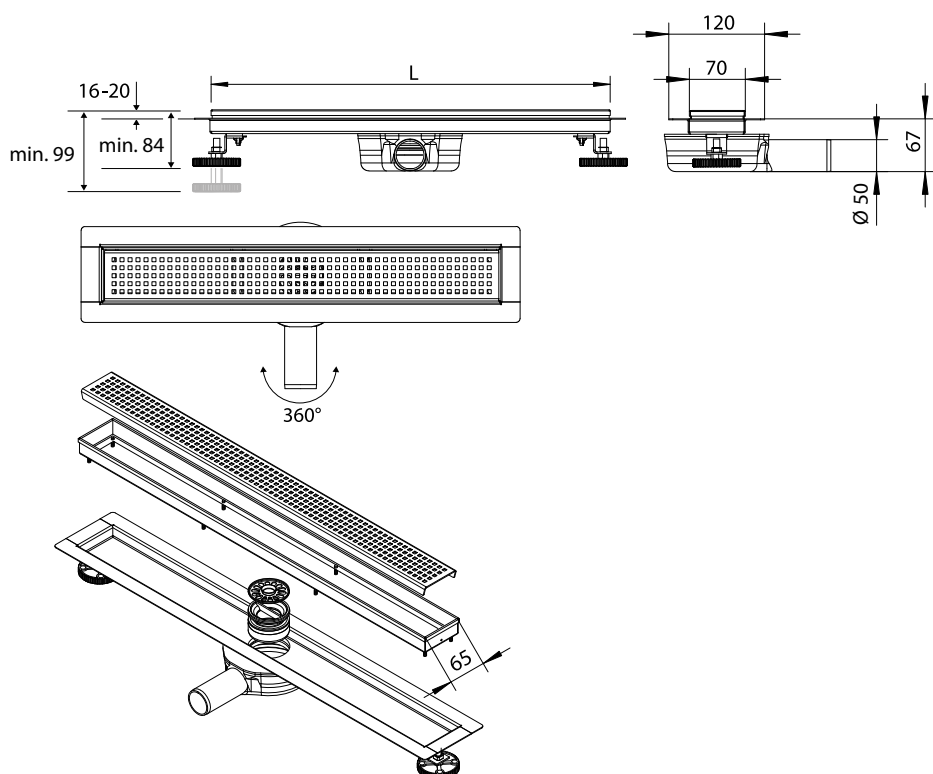



254653161

L = 1000 mm

254653131

L = 700 mm

254653151

L = 900 mm

254653121

L = 600 mm

254653141

L = 800 mm

254653111

L = 500 mm



Odtokový žlab, nerez

Shower drain, stainless steel

Duschrinne mit Rost, Edelstahl

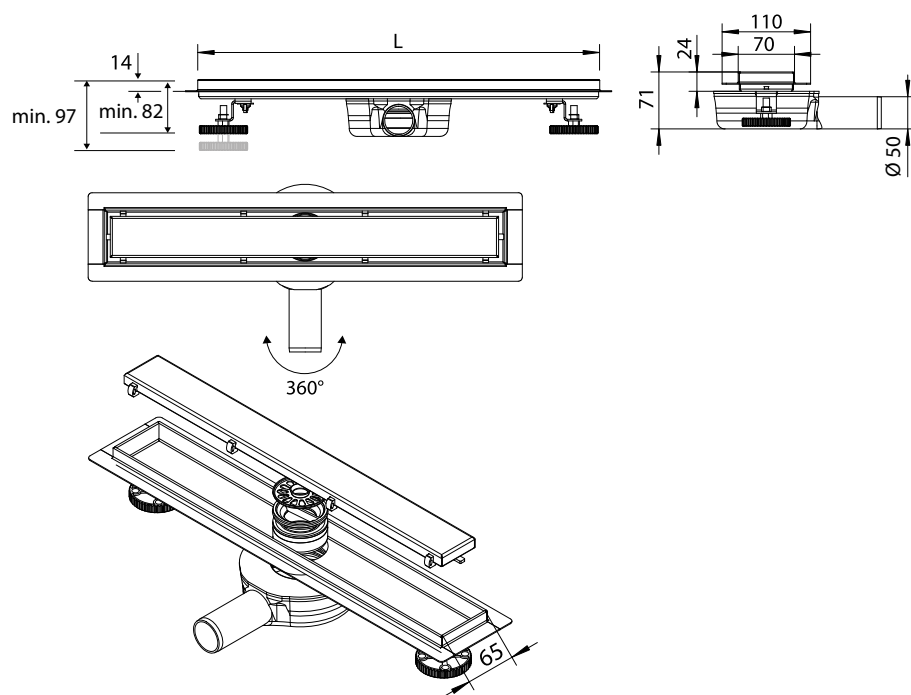

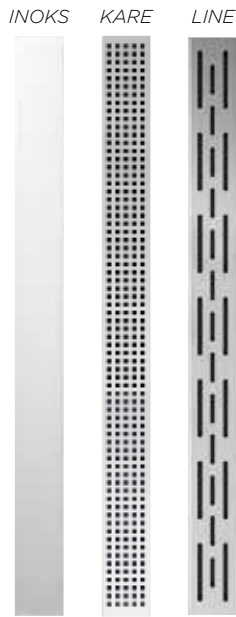

254657865 *INOKS*
254657065 *KARE*
254657465 *LINE*

L = 1000 mm

Mřížky pro odtokový žlab **254653161, 254653061**

Grates for shower drain
 254653161, 254653061
 Abdeckgitter für Duschrinne
 254653161, 254653061

254657835 *INOKS*
254657035 *KARE*
254657435 *LINE*

L = 700 mm

Mřížky pro odtokový žlab **254653131, 254653031**

Grates for shower drain
 254653131, 254653031
 Abdeckgitter für Duschrinne
 254653131, 254653031

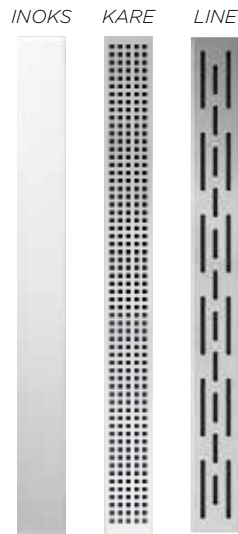

254657855 *INOKS*
254657055 *KARE*
254657455 *LINE*

L = 900 mm

Mřížky pro odtokový žlab **254653151, 254653051**

Grates for shower drain
 254653151, 254653051
 Abdeckgitter für Duschrinne
 254653151, 254653051

254657825 *INOKS*
254657025 *KARE*
254657425 *LINE*

L = 600 mm

Mřížky pro odtokový žlab **254653121, 254653021**

Grates for shower drain
 254653121, 254653021
 Abdeckgitter für Duschrinne
 254653121, 254653021

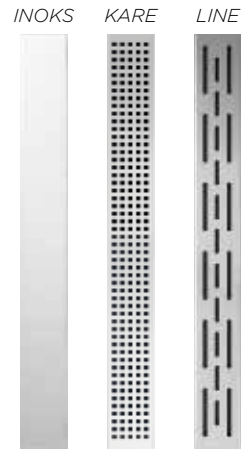

254657845 *INOKS*
254657045 *KARE*
254657445 *LINE*

L = 800 mm

Mřížky pro odtokový žlab **254653141, 254653041**

Grates for shower drain
 254653141, 254653041
 Abdeckgitter für Duschrinne
 254653141, 254653041

254657815 *INOKS*
254657015 *KARE*
254657415 *LINE*

L = 500 mm

Mřížky pro odtokový žlab **254653111, 254653011**

Grates for shower drain
 254653111, 254653011
 Abdeckgitter für Duschrinne
 254653111, 254653011



Vlastní design

Oboustranná mřížka INOKS – z jedné strany plný nerez, z druhé strany možnost vložení vlastní dlažby do tloušťky 13 mm.

Custom design

Double-sided INOX grate – on one side there is full stainless steel, on the other side you can insert your own tiles up to a thickness of 13 mm.

Eigenes Design

Doppelseitiges INOX-Gitter – auf der einen Seite die Möglichkeit, eigene Fliesen bis zu einer Stärke von 13 mm einzulegen.

SPRCHOVÝ PROGRAM
SHOWER accessories
DUSCHZUBEHÖR

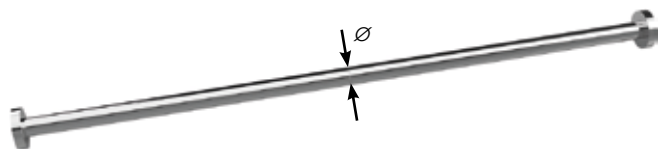

101120071

900×60×60 mm, ø 25 mm

101120081

1 000×60×60 mm, ø 25 mm

101120091

1 500×60×60 mm, ø 25 mm

101120101

2 000×60×60 mm, ø 25 mm

Tyč sprchového závěsu, skládaná*

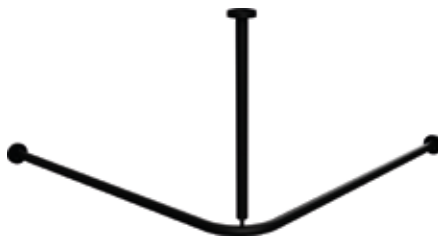
 Shower curtain holder, folding
 Duschvorhangstange

101120110

900×500×900 mm, ø 25 mm

Tyč sprchového závěsu rohová, skládaná, černá*

 Shower curtain holder, corner model, folding, black
 Eckduschvorhangstange, steckbare, schwarz

101120121

1 400×500×1 400 mm, ø 25 mm

101120231

1 300×500×1 300 mm, ø 25 mm

101120111

900×500×900 mm, ø 25 mm

Tyč sprchového závěsu rohová, skládaná*

 Shower curtain holder, corner model, folding
 Eckduschvorhangstange, steckbare

101114361

900×55×55 mm, ø 25 mm

101120012

1 000×55×55 mm, ø 25 mm

101120022

1 500×55×55 mm, ø 25 mm

101120032

2 000×55×55 mm, ø 25 mm

Tyč sprchového závěsu*

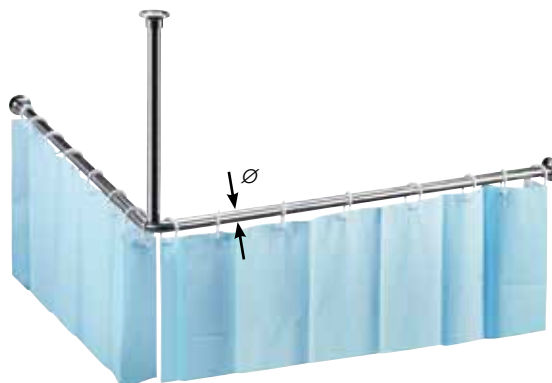
 Shower curtain holder
 Duschvorhangstange

101120052

1 400×500×1 400 mm, ø 25 mm

101120042

900×500×900 mm, ø 25 mm

Tyč sprchového závěsu rohová*

 Shower curtain holder, corner model
 Eckduschvorhangstange

**Tyče dodáváme bez sprchového závěsu./The rods are supplied without a shower curtain./Die Stange liefern wir ohne Duschvorhang.*

Objednejte si skládanou tyč sprchového závěsu na míru

Assemble your custom shower curtain holder from our components

Bauen Sie Ihren individuellen Duschvorhanghalter aus unseren Komponenten zusammen

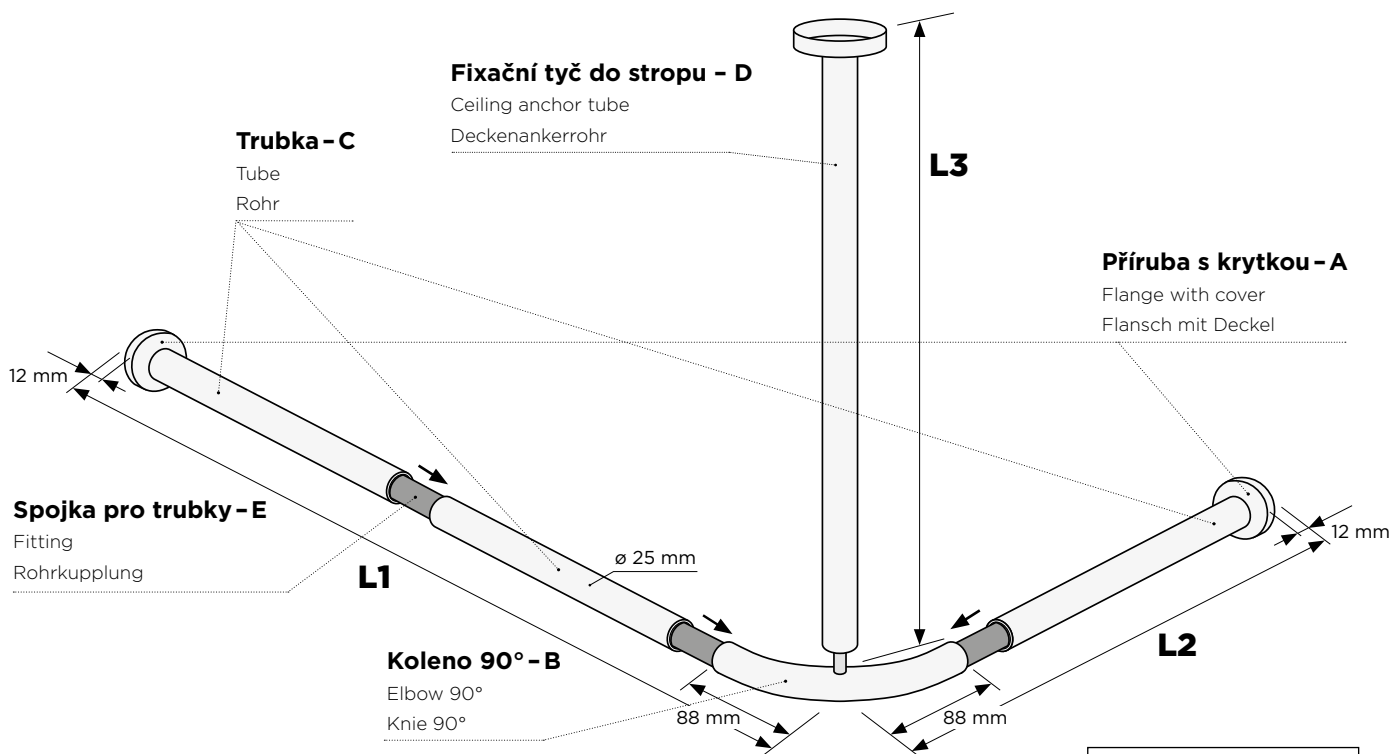

Postup zaměření jednotlivých délek tyčí sprchového závěsu:

Procedure for measuring individual lengths of shower curtain rods:

Vorgensweise zum Messen der einzelnen Längen von Duschvorhangstangen

L1:	$A + B$ = 100 mm	+ C + C
L2:	$A + B$ = 100 mm	+ C
L3:	D	



101120132

60×60×65 mm

Příruba s krytkou ke skládané tyči - A

Flange with cover - A
Flansch mit Rosette - A



101120152

115×23×23 mm

Spojka pro trubky ke skládaným tyčím - E

Straight connection - E
Verbindung gerade - E



101120222

145×25×145 mm

Koleno ke skládaným rohovým tyčím 90° - B

Corner connection 90° - B
Eckverbindung 90° - B



101120271

L = 1170 mm

101120182

L = 800 mm

101120202

L = 1000 mm

101120172

L = 700 mm

101120192

L = 900 mm

101120162

L = 600 mm

Trubka - C

Tube - C

Rohr - C



101120261

L = 1200 mm

101120251

L = 800 mm

101120142

L = 500 mm

101120241

L = 300 mm

Tyč do stropu pro skládané tyče - D

Ceiling anchor tube - D

Befestigung Deckenrohr - D

153653016

1800×1800 mm *pro sprchovou tyč/for shower curtain/
/für Duschvorhangstange: 101120071, 101114361*

153653026

2000×1800 mm *pro sprchovou tyč/for shower curtain/
/für Duschvorhangstange: 101120081, 101120012*

153653036

2400×1800 mm *pro sprchovou tyč/for shower curtain/
/für Duschvorhangstange: 101120091, 101120022,
101120111, 101120042*

153653046

3000×1800 mm *pro sprchovou tyč/for shower curtain/
/für Duschvorhangstange: 101120101, 101120032*

153653066

3600×1800 mm *pro sprchovou tyč/for shower curtain/
/für Duschvorhangstange: 101120121, 101120052*

Sprchový závěs

Shower curtain

Duschvorhang



BEZBARIÉROVÉ BYDLENÍ – HELP PROGRAM
Barrier-Free Living – HELP Program
Barrierefreies Wohnen – HELP-Programm



Možnosti provedení

Design possibilities/Ausführungsmöglichkeiten

Povrchová úprava

Surface finish/Ausführung

lesk

polished/poliert



komaxit bílý

white/weiss

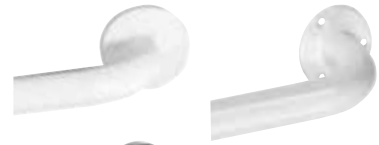

brus

brushed/gebürstet



komaxit černý

black/Schwarz



Příruba s krytkou

Flange with cover/Flansch mit Rosette



Příruba bez krytky

Flange without cover/Flansch ohne Rosette



Produkty

Products/Produkte



Podpěrné madlo ve tvaru U

Grab bar U-shaped/Stützgriff U-Förmig

600 mm 850 mm
750 mm 900 mm
813 mm

Podpěrné madlo ve tvaru U s držákem toaletního papíru

Grab bar U-shaped with toilet paper holder/
/Stützgriff U-Förmig mit Toilettenpapierhalter

600 mm 850 mm
750 mm 900 mm
813 mm

Madlo

Grab bar/Haltegriff

200 mm 600 mm 1000 mm
300 mm 700 mm 1100 mm
400 mm 800 mm 1200 mm
500 mm 900 mm 1500 mm



Sklopný úchyt ve tvaru U s držákem toaletního papíru

Folding grab bar U-shaped with toilet
paper holder/
/Stützklappgriff mit Toilettenpapierhalter

600 mm 850 mm
750 mm 900 mm
813 mm

Sklopný úchyt ve tvaru U

Folding grab bar U-shaped/Stützklappgriff

600 mm 850 mm
750 mm 900 mm
813 mm



Sklopný úchyt

Folding grab bar/Stützklappgriff

760 mm
850 mm



Sklopný úchyt s držákem toaletního papíru

Folding grab bar with toilet paper holder/
/Stützklappgriff mit Toilettenpapierhalter

760 mm
850 mm



Sklopný úchyt ve tvaru U, ukotvený do země

Folding grab bar U-shaped, ground mounted/
/Stützklappgriff U-Förmig, Bodenmontage

750 mm 850 mm
813 mm



Sklopný úchyt ve tvaru U s opěrnou nohou s držákem toaletního papíru

Folding grab bar U-shaped with supporting leg with toilet paper holder/
/Stützklappgriff in U-Förmig mit Standfuss mit Toilettenpapierhalter

600 mm 813 mm
750 mm 850 mm



Sklopný úchyt ve tvaru U s opěrnou nohou

Folding grab bar U-shaped with supporting leg/
/Stützklappgriff U-Förmig mit Standfuss

600 mm 813 mm
750 mm 850 mm



Úhlové madlo 120°

Angled grab bar 120°/
/Winkelgriff 120°

660×400 mm



Nástěnné opěrné držadlo*

Shower grab bar*/Haltegriff*

680 mm
890 mm

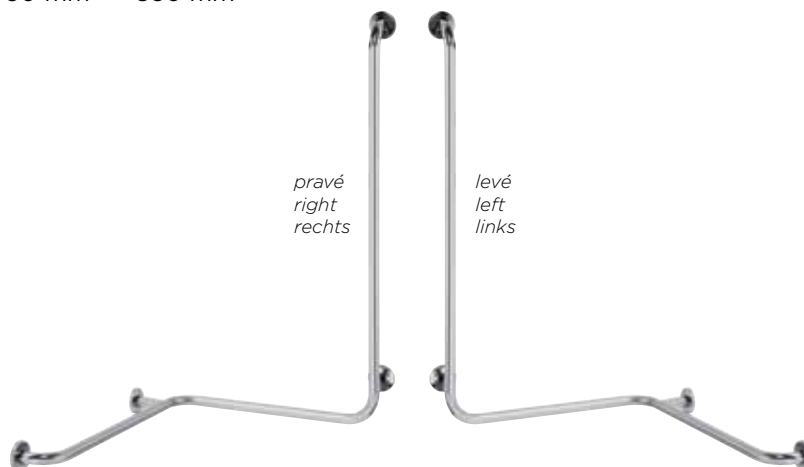

Madlo do sprchy se svislou opěrou*

Shower grab bar*/Duschgriff mit glatter senkrechter Stütze*

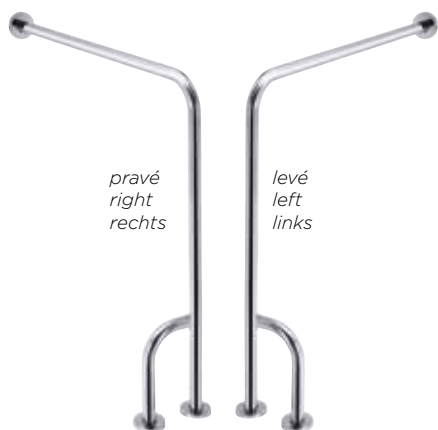

Opěrné madlo

Grab bar/Stützgriff

Madlo do sprchy

Shower grab bar/Duschgriff



Podpěrné madlo

Grab bar/Stützgriff

500 mm

760 mm



Sklopné sprchové sedátko

Reversible shower seat/Duschklappsitz

Sprchové sedátko

Shower seat/Duschsitz

Kompletní nabídka programu HELP: katalog BEMETA HELP, www.bemeta.cz

The complete offer of the HELP program: catalogHELP, www.bemeta.com

Das komplette Angebot des HELP-Programms: Katalog HELP, www.bemeta.com



301507852

600×100×70 mm

Odnímatelné madlo s krytkou

Removable bath grab bar with cover
Abnehmbarer Griff mit Abdeckung



102307015

355×55×75 mm

Madlo

Bath grab bar
Wannengriff



301507862

450×100×70 mm

Odnímatelné madlo s krytkou

Removable bath grab bar with cover
Abnehmbarer Griff mit Abdeckung



106107011

340×60×80 mm

Madlo

Bath grab bar
Wannengriff



106107021

390×230×80 mm

Madlo lomené, 45°

Bath grab bar angled, 45°
Wannengriff, 45°



106107031

455×250×120 mm

Madlo lomené s mýdlenkou, 45°

Bath grab bar angled with soap dish, 45°
Wannengriff abgewinkelt mit Seifenschale, 45°



301507882

400×180×230 mm

**Zádová opěrka s úchytkou,
odnímatelná**

Backrest with handle, removable
Rückenlehne mit Griff, abnehmbar



**POLÍČKY
SHELVEs
aBLagen**





101302401 *lesk | polished | Poliert*
 101302405 *mat | matt | Matt*
 101302400 *černá | black | Schwarz*
 300×2×135 mm **CYTRO**

Polička do spár

Shower self
 Eckduschablage



101302421 *lesk | polished | Poliert*
 101302425 *mat | matt | Matt*
 101302420 *černá | black | Schwarz*
 297×2×210 mm **CYTRO**

Polička do spár

Shower self
 Eckduschablage



101302441 *lesk | polished | Poliert*
 101302445 *mat | matt | Matt*
 101302440 *černá | black | Schwarz*
 297×2×210 mm **CYTRO**

Polička do spár

Shower self
 Eckduschablage



101302411 *lesk | polished | Poliert*
 101302415 *mat | matt | Matt*
 101302410 *černá | black | Schwarz*
 300×15×135 mm **CYTRO**

Polička do spár

Shower self
 Eckduschablage



101302431 *lesk | polished | Poliert*
 101302435 *mat | matt | Matt*
 101302430 *černá | black | Schwarz*
 297×15×210 mm **CYTRO**

Polička do spár

Shower self
 Eckduschablage



101302451 *lesk | polished | Poliert*
 101302455 *mat | matt | Matt*
 101302450 *černá | black | Schwarz*
 297×15×210 mm **CYTRO**

Polička do spár

Shower self
 Eckduschablage



146208036 **CYTRO**
 300×55×125 mm

Polička do sprchy

Shower shelf
 Ablage



102308061 **CYTRO**
 311×45×210 mm

Polička do sprchy rohová

Corner shower shelf
 Duschablage



102308081 **CYTRO**
 300×26×130 mm

Polička do sprchy

Shower shelf
 Ablage



104308072

230×30×120 mm

cytro

Polička do sprchy

Shower shelf
Ablage

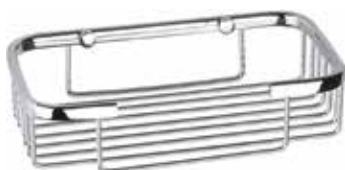

146208292

120×50×120 mm

cytro

Polička do sprchy

Shower shelf
Ablage



104308172

230×30×130 mm

cytro

Polička do sprchy rohová

Corner shower shelf
Duschablage



146208052

250×70×105 mm

cytro

Polička do sprchy

Shower shelf
Ablage



146208082

340×70×250 mm

cytro

Polička do sprchy rohová

Corner shower shelf
Duschablage



146208016

305×55×220 mm

cytro

Polička do sprchy rohová

Corner shower shelf
Duschablage



102308122 *lesk | polished | Poliert*

102308120 *černá | black | Schwarz*

245×60×150 mm

cytro

Polička do sprchy rohová

Corner shower shelf
Duschablage



146102272 *lesk | polished | Poliert*

146102275 *mat | matt | Matt*

270×40×110 mm

cytro

Polička do sprchy

Shower shelf
Ablage



102308080
300×26×115 mm

Dark

Polička do sprchy
Shower shelf
Ablage

153102390
290×47×220 mm

Dark

Polička do sprchy rohová
Corner shower shelf
Duschablage

102308051
lesk/polished/Glänzend
205×25×110 mm

cytro



102308261
lesk/polished/Glänzend
102308264
bílý/white/Weiss
102308260
černý/black/Schwarz
262×35×142 mm

cytro
white
Dark

101102365
180×50×97 mm

niva

Polička, samolepící
Metal shelf, self-adhesive
Metallablage, Selbstklebender

101102225
300×50×97 mm

niva

Polička, samolepící
Metal shelf, self-adhesive
Metallablage, Selbstklebender

Polička do sprchy rohová
Corner shower shelf
Duschablage



101502390
400×70×90 mm

Living



101502400
500×70×90 mm

Living

101502410
600×70×90 mm

Living

Polička
Metal shelf
Metallablage

101502420
400×120×90 mm

Living

Polička
Metal shelf
Metallablage

FÉNY
hairdryers
FÖHNE





946233066
160×223×100 mm

Fén s držákem nástěnný

Hair dryer with holder
Fön mit Wandhalter



945533168 černý/black/Schwarz
945533166 šedý/grey/grau
90×260×190 mm, 1800 W

Fén bez držáku, ionizace, rovná šňůra

Hair dryer without holder, ionic function, straight cable
Fön ohne Wandhalter, ionische Funktion, geradem Kabel



945533158 černý/black/Schwarz
945533154 bílý/white/Weiss
110×240×310 mm, 1600 W

Fén s držákem a zásuvkou, kroužková šňůra

Hairdryer wall-mounted, twisted cable
Fön mit Wandhalter, Ringschnur



999433088
černý, kroužková šňůra/black, twisted cable/Schwarz, Ringschnur
999433084-2
bílý, spirálová šňůra/white, spiral cable/Weiss, Spiralschnur
999433084
bílý, rovná šňůra/white, straight cable/Weiss, geradem Kabel
75×270×190 mm, 1400 W

Fén s držákem

Hair dryer with holder
Fön mit Wandhalter



945433088
černý, kroužková šňůra/black, twisted cable/Schwarz, Ringschnur
945433084
bílý, rovná šňůra/white, straight cable/Weiss, geradem Kabel
75×270×190 mm, 1400 W

Fén bez držáku

Hair dryer without holder
Fön ohne Wandhalter



199100200
250×320×10 mm

Sáček na fén

Hairdryer bag
Föntasche



945533074
110×245×140 mm, 1400 W

Fén s držákem nástěnný

Hair dryer with holder
Fön mit Wandhalter



945233066
110×240×310 mm, 1400 W

Fén s držákem nástěnný

Hair dryer with holder
Fön mit Wandhalter



945133016
180×370×120 mm, 900 W

Hotelový fén

Hotel hair dryer,
Pře Hotel-Fön klad DE

**KOSMETICKÁ ZRCÁTKA
COSMETIC MIRRORS
KOSMETIKSPIEGEL**



**116401412**

215×375×145 mm

Kosmetické zrcátko na postaveníOne-sided cosmetic mirror free standing
Kosmetikspiegel, einseitig, positionieren**112201412**

232×370×120 mm

Kosmetické zrcátko teleskopické na postaveníCosmetic bath mirror telescopic
Kosmetikspiegel teleskopische**112201252**

235×385×150 mm

Kosmetické zrcátko oboustranné na postaveníDouble-sided cosmetic mirror free standing
Kosmetikspiegel freistehend**116201252**

200×300×190 mm

Kosmetické zrcátko jednostranné na postaveníOne-sided cosmetic mirror free standing
Kosmetikspiegel rund, freistehend**112201332**

200×240×117 mm

Kosmetické zrcátko jednostrannéOne-sided cosmetic mirror
Rasier- und Kosmetikspiegel**112101150**

151×151×17 mm

Kosmetické zrcátko na nalepení + magnetGlue-on cosmetic mirror + magnet
Kosmetikspiegel zum Kleben + Magneten**116201332**

200×240×130 mm

Kosmetické zrcátko s kloubem 360°Cosmetic mirror with 360° joint
Kosmetikspiegel mit 360° Gelenk**116301522**

215×215×418 mm

Kosmetické zrcátko jednostrannéOne-sided cosmetic mirror
Rasier- und Kosmetikspiegel**172201512**

230×300×430 mm

Kosmetické zrcátko oboustrannéDouble-sided cosmetic mirror
Doppelseitiger Kosmetikspiegel



172201522
230×280×345 mm

Kosmetické zrcátko oboustranné
Double-sided cosmetic mirror
Doppelseitiger Kosmetikspiegel



112201518
238×255×465 mm

Kosmetické zrcátko oboustranné
Double-sided cosmetic mirror
Doppelseitiger Kosmetikspiegel



112201522
232×265×365 mm

Kosmetické zrcátko oboustranné
Double-sided cosmetic mirror
Doppelseitiger Kosmetikspiegel



112201514 **white**
bílý/white/Weiss
112201510 **dark**
černý/black/Schwarz
112201512
lesk/polished/Glänzend
230×280×430 mm

Kosmetické zrcátko oboustranné
Double-sided cosmetic mirror
Doppelseitiger Kosmetikspiegel



112101521 **omega**
140×140×200 mm

Kosmetické zrcátko jednostranné
One-sided cosmetic mirror
Rasier- und Kosmetikspiegel

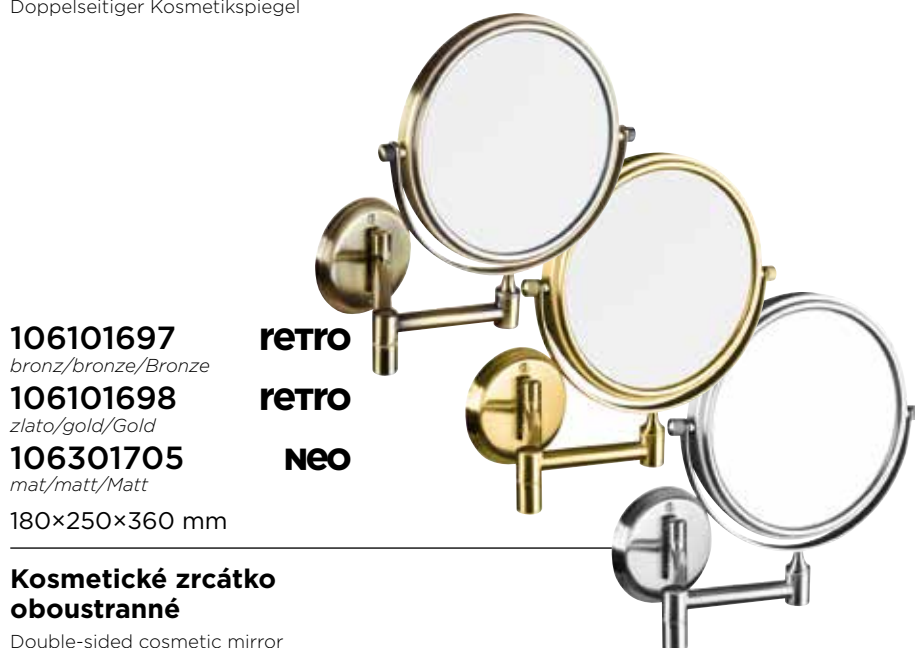

106101697 **retro**
bronz/bronze/Bronze
106101698 **retro**
zlato/gold/Gold
106301705 **neo**
mat/matt/Matt
180×250×360 mm

Kosmetické zrcátko oboustranné
Double-sided cosmetic mirror
Doppelseitiger Kosmetikspiegel



106301122 **omega**
185×260×420 mm

Kosmetické zrcátko oboustranné
Double-sided cosmetic mirror
Doppelseitiger Kosmetikspiegel



112101121 **omega**

140×140×80 mm

Kosmetické zrcátko jednostranné

One-sided cosmetic mirror
Rasier- und Kosmetikspiegel



132201172 **BETA**

112201172
200×535×140 mm

Kosmetické zrcátko na tyči jednostranné

One-sided cosmetic mirror on a pole
Rasier- und Kosmetikspiegel



116201792
200×515×120 mm

Kosmetické zrcátko na tyči jednostranné

One-sided cosmetic mirror on a pole
Rasier- und Kosmetikspiegel



116501682
200×575×155 mm

Kosmetické zrcátko na tyči s LED osvětlením

Cosmetic mirror with LED lighting
Kosmetikspiegel



116301142
220×200×370 mm

Kosmetické zrcátko s LED osvětlením

Cosmetic mirror with LED lighting
Rasier- und Kosmetikspiegel mit LED Beleuchtung



116301802
260×230×425 mm

Kosmetické zrcátko s LED osvětlením

Cosmetic mirror with LED lighting
Rasier- und Kosmetikspiegel mit LED Beleuchtung



116101142
220×200×365 mm

Kosmetické zrcátko s LED osvětlením

Cosmetic mirror with LED lighting
Rasier- und Kosmetikspiegel mit LED Beleuchtung

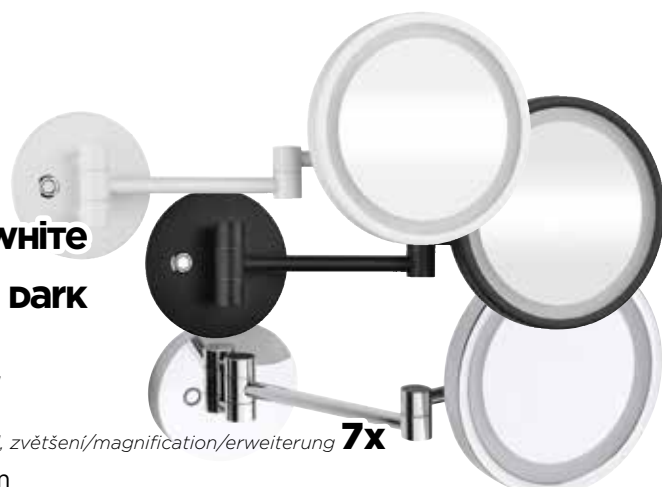

112101144 **white**
bílý/white/Weiss

112101140 **DARK**
černý/black/Schwarz

112101149
lesk/polished/Glänzend

112101779 **7X**
lesk/polished/Glänzend, zvětšení/magnification/erweiterung

255×200×400 mm

Kosmetické zrcátko s LED osvětlením

Cosmetic mirror with LED lighting
Rasier- und Kosmetikspiegel mit LED Beleuchtung



116401772

240×240×390 mm

Kosmetické zrcátko s LED osvětlením

Cosmetic mirror with LED lighting
 Rasier- und Kosmetikspiegel mit LED Beleuchtung



116101772

225×200×365 mm

Kosmetické zrcátko s LED osvětlením

Cosmetic mirror with LED lighting
 Rasier- und Kosmetikspiegel mit LED Beleuchtung



116101802

230×210×400 mm

Kosmetické zrcátko s LED osvětlením

Cosmetic mirror with LED lighting
 Rasier- und Kosmetikspiegel mit LED Beleuchtung



116201772

335×200×280 mm

Kosmetické zrcátko s LED osvětlením

Cosmetic mirror with LED lighting
 Rasier- und Kosmetikspiegel mit LED Beleuchtung



116101770

225×200×365 mm

Kosmetické zrcátko s LED osvětlením

Cosmetic mirror with LED lighting
 Rasier- und Kosmetikspiegel mit LED Beleuchtung



116201310

130×300×190 mm

Kosmetické zrcátko jednostranné na postavení

One-sided cosmetic mirror free standing
 Kosmetikspiegel eckig, freistehend



116201312

130×300×190 mm

Kosmetické zrcátko jednostranné na postavení

One-sided cosmetic mirror free standing
 Kosmetikspiegel eckig, freistehend



116401312

215×375×145 mm

Kosmetické zrcátko na postavení

One-sided cosmetic mirror free standing
 Kosmetikspiegel, einseitig, positionieren



112201222

130×240×100 mm

Kosmetické zrcátko jednostranné

One-sided cosmetic mirror
 Rasier- und Kosmetikspiegel

**116201222**

130×245×130 mm

Kosmetické zrcátko s kloubem 360°Cosmetic mirror with 360° joint
Kosmetikspiegel mit 360° Gelenk**153301612**

195×320×390 mm

Kosmetické zrcátko oboustrannéDouble-sided cosmetic mirror
Doppelseitiger Kosmetikspiegel**116301212**

215×215×462 mm

Kosmetické zrcátko jednostrannéOne-sided cosmetic mirror
Rasier- und Kosmetikspiegel**116501672**

200×550×155 mm

Kosmetické zrcátko na tyči s LED osvětlenímCosmetic mirror with LED lighting
Kosmetikspiegel**116101202**

240×200×410 mm

Kosmetické zrcátko s LED osvětlenímCosmetic mirror with LED lighting
Rasier- und Kosmetikspiegel mit LED Beleuchtung**116201202**

325×200×310 mm

Kosmetické zrcátko s LED osvětlenímCosmetic mirror with LED lighting
Rasier- und Kosmetikspiegel mit LED Beleuchtung**112101202**

205×205×400 mm

Kosmetické zrcátko s LED osvětlenímCosmetic mirror with LED lighting
Rasier- und Kosmetikspiegel mit LED Beleuchtung**116301812**

280×225×470 mm

Kosmetické zrcátko s LED osvětlenímCosmetic mirror with LED lighting
Rasier- und Kosmetikspiegel mit LED Beleuchtung**112102672**

220×220×390 mm

Kosmetické zrcátko s osvětleným rámečkemCosmetic bath mirror with LED
Rasier- und Kosmetikspiegel mit LED Beleuchtung

DOPLŇKY
accessories
ZUBEHÖR



**101106154***bílý/white/Weiss***101106150***černý/black/Schwarz***101106155***lesk/polished/Glänzend*

25×85×34 mm

Háček na dveře

Hook for door

Türhaken

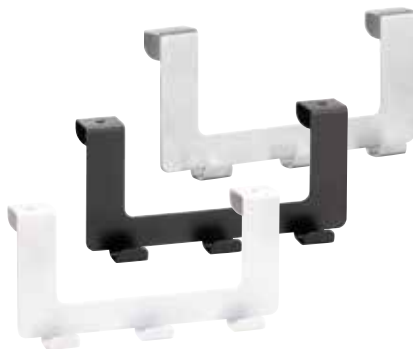
**WHITE****101106224***bílý/white/Weiss***DARK****101106220***černý/black/Schwarz***NEO****101106225***lesk/polished/Glänzend*

175×85×34 mm

Věšák na dveře se 3 háčky

Hanger with 3 hooks for door

Türhaken mit 3 Haken

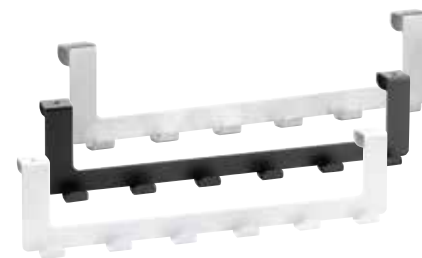
**WHITE****101106234***bílý/white/Weiss***DARK****101106230***černý/black/Schwarz***NEO****101106235***lesk/polished/Glänzend*

350×87×34 mm

WHITE**DARK****NEO****Věšák na dveře se 6 háčky**

Hanger with 6 hooks for door

Türhaken mit 6 Haken

**164106360****164106361****164106365**

45×45×36 mm

easy01**easy01****easy01***černý/black/Schwarz**lesk/polished/Poliert**mat/matt/Matt***Háček**

Single robe hook

Kleiderhaken

**163106360****163106361****163106365**

45×45×36 mm

easy**easy****easy***černý/black/Schwarz**lesk/polished/Poliert**mat/matt/Matt***Háček, samolepící**

Single robe hook, self-adhesive

Kleiderhaken, Selbstklebender

**164106370****164106371****164106375**

100×45×36 mm

easy01**easy01****easy01***černý/black/Schwarz**lesk/polished/Poliert**mat/matt/Matt***Věšák se 2 háčky**

Hanger with 2 hooks

Doppelkleiderhaken

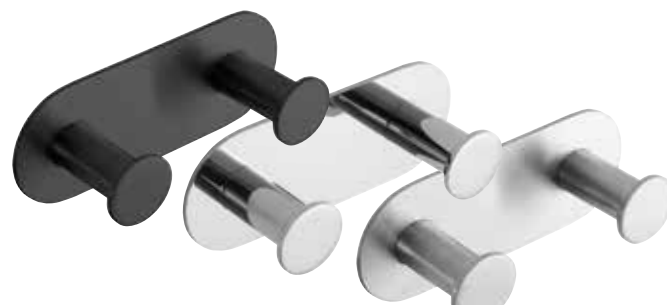
**163106370****163106371****163106375**

100×45×36 mm

easy**easy****easy***černý/black/Schwarz**lesk/polished/Poliert**mat/matt/Matt***Věšák se 2 háčky, samolepící**

Hanger with 2 hooks, self-adhesive

Doppelkleiderhaken, Selbstklebender



104106035

55×55×50 mm

NEO

Háček dvojitý

Double robe hook
Doppelkleiderhaken



104106065

55×55×50 mm

NEO

Háček

Single robe hook
Kleiderhaken



104506095

ø 16×30 mm

NEO

104106165

ø 16×55 mm

NEO

Háček

Single robe hook
Kleiderhaken



104106153

20×70×40 mm

NEO

Háček na dveře

Hook for door
Türhaken



101506300

28×53×21 mm

LIVING

Háček, samolepící

Single robe hook, self-adhesive
Kleiderhaken, Selbstklebender



101506310

28×113×21 mm

LIVING

Háček, samolepící

Single robe hook, self-adhesive
Kleiderhaken, Selbstklebender



101106035

48×85×22 mm

niva

Háček dvojitý, samolepící

Double robe hook, self-adhesive
Doppelkleiderhaken, Selbstklebender



104204015

355×55×65 mm

NEO

104204125

505×55×65 mm

NEO

104204045

655×55×65 mm

NEO

Držák ručníků

Towel holder
Handtuchhalter



104204105

55×165×445 mm

NEO

Držák ručníků dvojitý otočný

Double swivel towel holder
Doppelhandtuchhalter schwenkbar

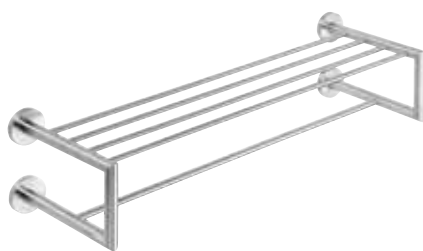
**104205105**

655×160×225 mm

NEO**Držák ručníků dvojitý s hrazdou**Double towel holder with rail
Doppelhandtuchhalter**104205075**

655×110×215 mm

NEO**Držák ručníků s hrazdou**Towel holder with rail
Handtuchhalter**101112135**

335×50×70 mm

niva**Držák ručníků, samolepící**Towel holder, self-adhesive
Handtuchhalter, Selbstklebender**OSTATNÍ DOPLŇKY**

Other accessories / Andere Zubehör

**168106062****169106062**

52×52×40 mm

**circum
QUADRA****Háček**Single robe hook
Kleiderhaken**168106032****169106032**

86×52×63 mm

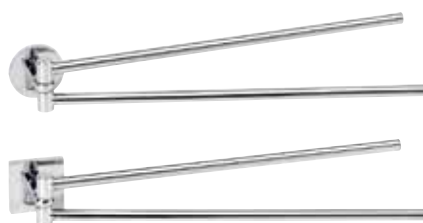
**circum
QUADRA****Háček dvojitý**Double robe hook
Doppelkleiderhaken**168204192****169204192**

52×52×420 mm

**circum
QUADRA****Držák ručníků dvojitý otočný**Double swivel towel holder
Doppelhandtuchhalter schwenkbar**168104062****169104062**

168×166×60 mm

**circum
QUADRA****Držák ručníků**Towel holder
Handtuchhalter

zařizovací předměty
FURNISHING ITEMS
einrichtungsgegenstände

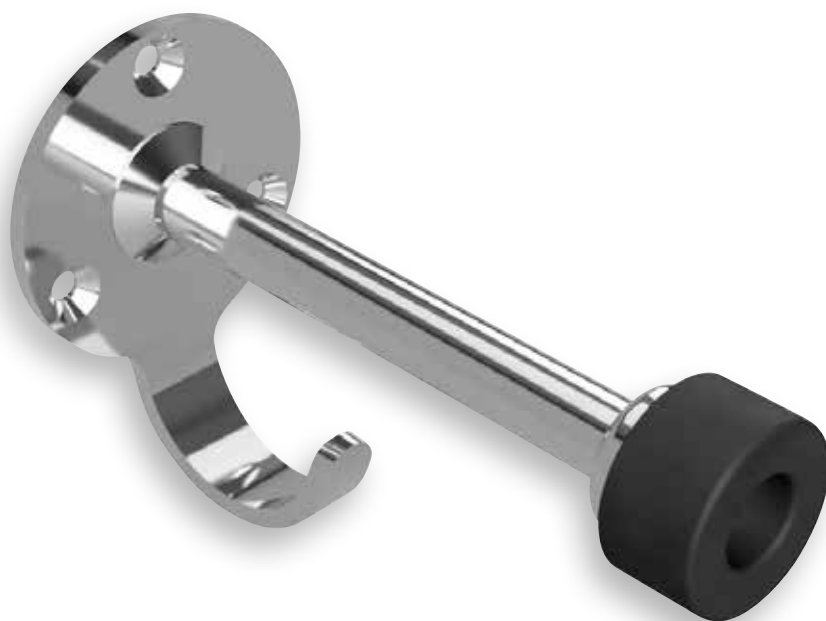

**138235035**

900×520×105 mm

**Přebalovací pult nástěnný,
horizontální**Wall mounted baby changing station,
horizontal
Wickeltisch**138235016**

855×585×107 mm

**Přebalovací pult nástěnný,
horizontální**Wall mounted baby changing station, horizontal
Wickeltisch**138235026**

480×870×885 mm

Přebalovací pult nástěnnýWall mounted baby changing station
Wickeltisch**106105181**

220×30×40 mm

Věšák se 3 háčkyHanger with 3 hooks
Dreifachhaken**101832011**

45×65×40 mm

Otvírák lahvíBottle opener
Flaschenöffner**123126022**

ø 95×45 mm, l = 3 000 mm

Šňůra na prádloClothesline
Wäscheleine



346218121 *lesk/polished/Glänzend*
346218125 *mat/matt/Matt*
 46×65×100 mm

Dveřní doraz na stěnu, nerez

Door stop on the wall, stainless steel
 Bodentürstopper an der Wand, Edelstahl



346218021 *lesk/polished/Glänzend*
346218025 *mat/matt/Matt*
 50×95×50 mm

Dveřní doraz na stěnu, nerez

Door stop on the wall, stainless steel
 Bodentürstopper an der Wand, Edelstahl



346218211 *lesk/polished/Glänzend*
346218215 *mat/matt/Matt*
 37×40×37 mm

Dveřní doraz na zem, nerez

Door stop on the floor, stainless steel
 Bodentürstopper, Edelstahl

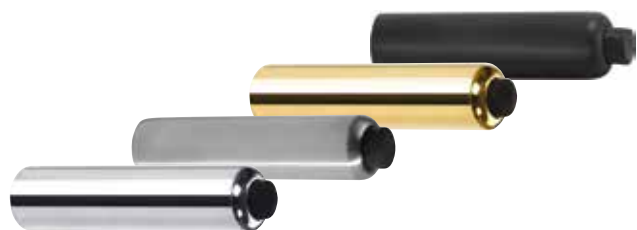

101218022 *chrom/chrome/Verchromt*
101218025 *nerez/stainless steel/Edelstahl*
101218027 *mosaz/brass/Messing*
101218020 *černý/black/Schwarz*
 18×18×80 mm

Dveřní doraz na stěnu

Door stop on the wall
 Bodentürstopper an der Wand



101218012 *chrom/chrome/Verchromt*
101218015 *nerez/stainless steel/Edelstahl*
101218017 *mosaz/brass/Messing*
101218010 *černý/black/Schwarz*
 33×30×33 mm

Dveřní doraz na zem

Door stop on the floor
 Bodentürstopper



346218011 *lesk/polished/Glänzend*
346218015 *mat/matt/Matt*
 35×40×35 mm

Dveřní doraz na zem

Door stop on the floor
 Bodentürstopper



346218111 *lesk/polished/Glänzend*
346218115 *mat/matt/Matt*
 46×46×46 mm

Dveřní doraz na zem

Door stop on the floor
 Bodentürstopper

pravá/right/Rechts



levá/left/Links



201541061

pravá, nerez lesk/right, stainless polished/
Rechts, Edelstahl Glänzend

201541051

levá, nerez lesk/left, stainless polished/
Links, Edelstahl Glänzend

201541065

pravá, nerez mat/right, stainless mat/
Rechts, Edelstahl Matt

201541055

levá, nerez mat/left, stainless mat/
Links, Edelstahl Matt

201541064

pravá, Fe bílá/right, Fe white/Rechts, Fe Weiss

201541054

levá, Fe bílá/left, Fe white/ Links, Fe Weiss

201541060

pravá, Fe černá/right, Fe black/Rechts,
Fe Schwarz

201541050

levá, Fe černá/left, Fe black/Links, Fe Schwarz

56×150×490 mm

Konzole umyvadlová s držákem ručníků

Washbasin console with towel holder

Konzole für Waschbeckenplatte



101042065

60×860×400 mm

Zástěna mezi pisoáry

Urinal partitions

Urinal-Trennwand Edelstahl



101042075

30×800×390 mm

Zástěna mezi pisoáry

Urinal partitions

Urinal-Trennwand Edelstahl

pravá/right/Rechts



levá/left/Links

201541014

79×100×300 mm
zatížení/weight/Belastung 30 kg

201541024

79×100×400 mm
zatížení/weight/Belastung 30 kg

201541034

79×100×400 mm
zatížení/weight/Belastung 50 kg

201541044

79×100×450 mm
zatížení/weight/Belastung 50 kg

Konzole umyvadlová (2 ks)

Washbasin console (pair)

Konzole für Waschbeckenplatte (Paar)



101542070

180×735×355 mm

Zástěna mezi pisoáry

Urinal partitions

Urinal-Trennwand Edelstahl



111054002

75×75×2 mm

Muži - A

Man
Männer



111022032

lesk/polished/Glänzend

111022035

mat/matt/Matt

120×120×2 mm

Ikona - Muži

Pictogram - Man
Piktogramm - Männer



111022072

lesk/polished/Glänzend

111022075

mat/matt/Matt

120×120×2 mm

Ikona - Sprcha

Pictogram - Shower
Piktogramm - Dusche



111022062

lesk/polished/Glänzend

111022065

mat/matt/Matt

120×120×2 mm

Ikona - Přebalovna

Pictogram - Baby changing room
Piktogramm - Wickelraum



111054007

75×75×2 mm

Ženy - A

Woman
Frauen



111022042

lesk/polished/Glänzend

111022045

mat/matt/Matt

120×120×2 mm

Ikona - Ženy

Pictogram - Woman
Piktogramm - Frauen



111022092

lesk/polished/Glänzend

111022095

mat/matt/Matt

120×120×2 mm

Ikona - Úklidová místnost

Pictogram - Cleaning room
Piktogramm - Abstellraum



108022072

lesk/polished/Glänzend

108022075

mat/matt/Matt

80×35×2 mm

Ikona - WC

Pictogram - WC
Piktogramm - WC



111054001

75×75×2 mm

Invalidé - A

Disabled
Invaliden



111022022

lesk/polished/Glänzend

111022025

mat/matt/Matt

120×120×2 mm

Ikona - Invalidé

Pictogram - Disabled
Piktogramm - Invaliden

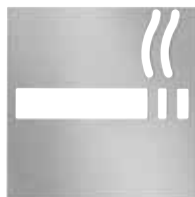

111022012

lesk/polished/Glänzend

111022015

mat/matt/Matt

120×120×2 mm

Ikona - Kouření povoleno

Pictogram - Smoking
Piktogramm - Rauchen gestattet



108022062

lesk/polished/Glänzend

108022065

mat/matt/Matt

40×85×2 mm

Ikona - WC dámy

Pictogram - Ladies toilet
Piktogramm - Damen



111054004

75×75×2 mm

Sprcha - A

Shower
Dusche



111022082

lesk/polished/Glänzend

111022085

mat/matt/Matt

120×120×2 mm

Ikona - WC, čtverec

Pictogram - WC,
Piktogramm - WC



111022052

lesk/polished/Glänzend

111022055

mat/matt/Matt

120×120×2 mm

Ikona - Kouření zakázáno

Pictogram - No smoking
Piktogramm - Rauchen verboten



108022052

lesk/polished/Glänzend

108022055

mat/matt/Matt

40×85×2 mm

Ikona - WC páni

Pictogram - Gentlemen toilet
Piktogramm - Herren

Kompletní nabídka ikonComplete menu icons
Vollständiges Menü mit Symbolen

Symbol	Název / Name / DE	Registrační číslo / Registration number / Registrierungsnummer			
		kruh, lesk circle, polished ring, poliert	kruh, mat circle, mat ring, matt	čtverec, lesk square, polished quadrat, poliert	čtverec, mat square, mat quadrat, matt
	invalidé / disabled / Invaliden	111054001	111055001	111056001	111057001
	muži / man / Männer	111054002	111055002	111056002	111057002
	ženy / woman / Frauen	111054007	111055007	111056007	111057007
	ženy a muži / man and woman / Frauen und Männer	111054072	111055072	111056072	111057072
	přebalovna / baby nursery room / Wickelraum	111054003	111055003	111056003	111057003
	sprcha / shower / Dusche	111054004	111055004	111056004	111057004
	úklidová místnost / cleaning room / Putzraum	111054005	111055005	111056005	111057005
	wc	111054006	111055006	111056006	111057006
	bazén / swimming pool / Schwimmbad	111054008	111055008	111056008	111057008
	děti / children / Kinder	111054009	111055009	111056009	111057009
	dětský koutek / children's corner / Kinderecke	111054010	111055010	111056010	111057010
	kočárkárna / carriage house / Kutschenladen	111054011	111055011	111056011	111057011
	kolárna / bike shed / Steuerhaus	111054012	111055012	111056012	111057012
	koš / basket / Korb	111054013	111055013	111056013	111057013
	modlitebna / chapel / Kapelle	111054014	111055014	111056014	111057014
	pokladna / cash register / Kasse	111054015	111055015	111056015	111057015
	posilovna / fitness / Fitnessstudio	111054016	111055016	111056016	111057016
	šatna / cloakroom // Garderobe	111054017	111055017	111056017	111057017
	vířivka / whirlpool // Whirlpool	111054018	111055018	111056018	111057018
	wellness	111054019	111055019	111056019	111057019
	wi-fi	111054020	111055020	111056020	111057020
	kouření povoleno / smoking / Rauchen	111054021	111055021	111056021	111057021
	kouření zakázáno / no smoking / Rauchen verboten	111054022	111055022	111056022	111057022
	fotografování zakázáno / No photography allowed / Fotografieren verboten	111054023	111055023	111056023	111057023
	jídlu zakázáno / food prohibited / Essen verboten	111054024	111055024	111056024	111057024
	zákaz 1 / ban 1 / Verbot 1	111054025	111055025	111056025	111057025
	zákaz 2 / ban 2 / Verbot 2	111054026	111055026	111056026	111057026
	zvířata na vodítku / animals on a leash / Tiere an der Leine	111054027	111055027	111056027	111057027
	zvířata zakázáno / pets prohibited / Tiere verboten	111054028	111055028	111056028	111057028
	číslice / numeral // Ziffer	111054029	111055029	111056029	111057029
	eskalátor / escalator / Rolltreppe	111054030	111055030	111056030	111057030
	eskalátor dolů / escalator down / Rolltreppe nach unten	111054031	111055031	111056031	111057031
	eskalátor nahoru / escalator up / Rolltreppe hoch	111054032	111055032	111056032	111057032
	patro / floor / Boden	111054033	111055033	111056033	111057033
	informace / information / Information	111054034	111055034	111056034	111057034
	nadzemní podlaží / above ground floor / Obergeschoss	111054035	111055035	111056035	111057035



Symbol	Název / Name / DE	Registrační číslo / Registration number / Registrierungsnummer			
		kruh, lesk circle, polished ring, poliert	kruh, mat circle, mat ring, matt	čtverec, lesk square, polished quadrat, poliert	čtverec, mat square, mat quadrat, matt
	parkování / parking / Parken	111054036	111055036	111056036	111057036
	patro / floor / Boden	111054037	111055037	111056037	111057037
	po schodech dolů / down the stairs / die Treppe hinunter	111054038	111055038	111056038	111057038
	po schodech nahoru / upstairs / die Treppe hinauf	111054039	111055039	111056039	111057039
	podzemní podlaží / underground floor / Untergeschoss	111054040	111055040	111056040	111057040
	pokoj / room / Zimmer	111054041	111055041	111056041	111057041
	pomlčka „až“ / dash “up” / Bindestrich „bis zu“	111054042	111055042	111056042	111057042
	sem / pull / ziehen	111054043	111055043	111056043	111057043
	sem / pull / ziehen	111054044	111055044	111056044	111057044
	sem / pull / ziehen	111054048	111055048	111056048	111057048
	sem-pull/sem-pull	111054049	111055049	111056049	111057049
	tam / push / drücken	111054045	111055045	111056045	111057045
	tam / push / drücken	111054046	111055046	111056046	111057046
	tam / push / drücken	111054054	111055054	111056054	111057054
	tam / push / drücken	111054055	111055055	111056055	111057055
	recepcie / reception / Rezeption	111054047	111055047	111056047	111057047
	šipka / arrow / Pfeil	111054050	111055050	111056050	111057050
	šipka obousměrná / bidirectional arrow / Zwei-Wege-Pfeil	111054051	111055051	111056051	111057051
	šipka úhlopříčná levá / diagonal left arrow / diagonaler Pfeil nach links	111054052	111055052	111056052	111057052
	šipka úhlopříčná pravá / diagonal right arrow / diagonaler Pfeil nach rechts	111054053	111055053	111056053	111057053
	únikový východ / emergency exit / Notausgang	111054056	111055056	111056056	111057056
	vchod / entrance / Eingang	111054057	111055057	111056057	111057057
	východ / exit / Ausfahrt	111054058	111055058	111056058	111057058
	výtah / lift / Aufzug	111054059	111055059	111056059	111057059
	bar / bar / Bar	111054060	111055060	111056060	111057060
	kavárna / cafe / Cafe	111054061	111055061	111056061	111057061
	kuchyně / kitchen / Küche	111054062	111055062	111056062	111057062
	restaurace / restaurant / Restaurant	111054063	111055063	111056063	111057063
	bezpečnostní kamera / safety camera / Überwachungskamera	111054064	111055064	111056064	111057064
	desinfekce / disinfection / Desinfektion	111054065	111055065	111056065	111057065
	hasičí přístroj / fire extinguisher / Feuerlöscher	111054066	111055066	111056066	111057066
	lékárnička / first aid kit / Erste-Hilfe-Kasten	111054067	111055067	111056067	111057067
	požární hadice / fire hose / Feuerwehrschauch	111054068	111055068	111056068	111057068
	rozestupy / spacing / Abstände	111054069	111055069	111056069	111057069
	zakrytí úst / covering mouth / den Mund bedecken	111054070	111055070	111056070	111057070
	zdravotník / paramedic / Sanitäter	111054071	111055071	111056071	111057071

ZAKÁZKOVÁ VÝROBA CUSTOM PRODUCTION SONDERANFERTIGUNG

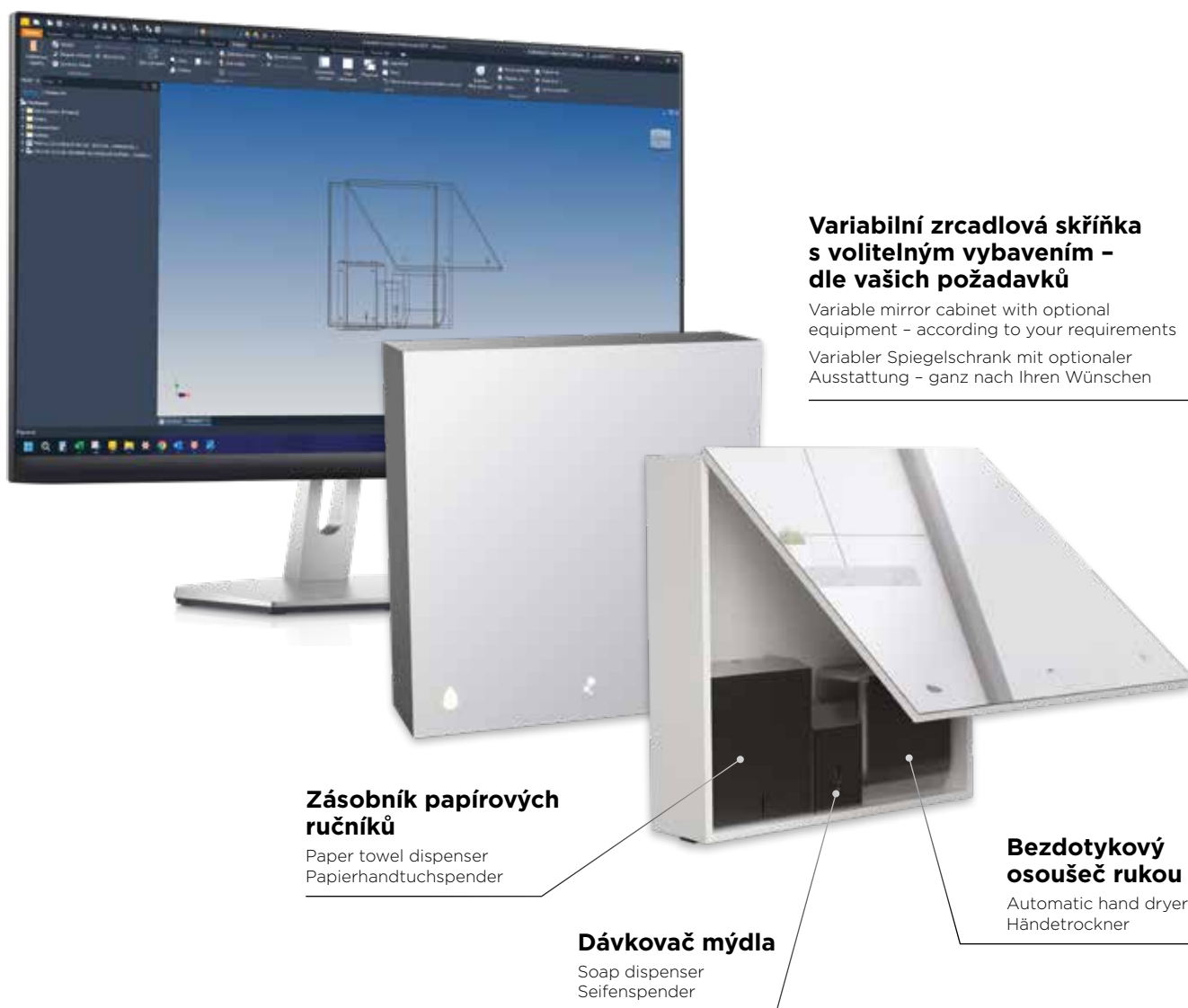

Variabilní zrcadlová skříňka s volitelným vybavením – dle vašich požadavků

Variable mirror cabinet with optional
equipment – according to your requirements
Variabler Spiegelschrank mit optionaler
Ausstattung – ganz nach Ihren Wünschen

Zásobník papírových ručníků

Paper towel dispenser
Papierhandtuchspender

Dávkovač mýdla

Soap dispenser
Seifenspender

Bezdotykový osoušeč rukou

Automatic hand dryer
Händetrockner

Naše služby pokračují i tam, kde ostatní končí.

Díky vlastní kovovýrobě upravíme
nebo vyrobíme produkty atypických
rozměrů či v nestandardních
barevných variantách.

Our services continue where others leave off.

Thanks to our own metal production
we can modify or produce products
of atypical dimensions
or in non-standard colour variants.

Unsere Leistungen machen dort weiter, wo andere aufhören.

Dank unserer eigenen Metallproduktion
können wir Produkte mit atypischen
Abmessungen oder in nicht standardisierten
Farbvarianten modifizieren oder herstellen.

Úprava stávající nabídky i výroba na míru

Modification of the existing offer as well as tailor-made production

Änderung des bestehenden Angebots sowie maßgeschneiderte Produktion

Atypické rozměry

Atypical dimensions/sizes/proportions

Atypische Abmessungen

Nestandardní barevné kombinace

Non-standard color combination

Nicht standardmäßige Farbkombination

**Stojan na zavazadla**

Luggage rack

Gepäckträger

**Konferenční stolek**

Conference table

Konferenztisch

**Hotelový táč**

Hotel tray

Hoteltablett

**Podnož pod konferenční stolek**

Leg under the coffee table

Beinfreiheit unter dem Tisch

**Výčepní stojan**

Tap stand

Wasserhahnständer

Realizace na zakázku

Realisation to order

Realisierung auf Bestellung



Katalogy Bemeta

Catalogues Bemeta | Bemeta Ergänzungskataloge

Prohlédněte si všechny naše katalogy s kompletní nabídkou na www.bemeta.cz

You can find all our catalogs at www.bemeta.com

Alle unsere Kataloge mit vollständigem Angebot finden Sie unter www.bemeta.de



Změny produktů, cen, designu a informací vyhrazeny. Informace a zobrazení odpovídají době vydání katalogu. Za tiskové chyby neručíme.

Changes in products, prices, design and informations reserved. Informations and images are corresponding to the time of the catalog publication.

Änderungen der Produkten, Preisen, Design und Informationen vorbehalten. Informationen und Ansichten entsprechen dem Zeitpunkt der Ausgabe vom Katalog. Für Druckfehler tragen wir keine Verantwortung.

2/2025

■BEMETA

BEMETA DESIGN s. r. o.
Žatčany 28
664 53 Czech Republic

www.bemeta.cz