

■ BEMETA



stainless2023











Piktogramy

Pictograms

Piktogramm-Symbole

Графические символы

-  **Montáž na zeď**
Wall mounting/Wandmontage/Настенный монтаж
-  **Zabudovaný do zdi**
Built into the wall/In die Wand eingebaut
Встраиваемый в стену
-  **Volně stojící**
Freestanding/Freistehend/Отдельностоящий
-  **Manuální ovládání**
Manual control/Manuelle Kontrolle
Механическое управление
-  **Manuální ovládání pákou**
Manual lever control/Manuelle Hebelsteuerung
Механическое управление с рычагом
-  **Bezdotykové ovládání**
Touchless control/Berührungslose Steuerung
Бесконтактное управление
-  **Tekuté mýdlo**
Liquid soap/Flüssigseife/Жидкое мыло
-  **Dezinfekční gel**
Disinfectant gel/Desinfektionsgel
Дезинфицирующий гель
-  **Pěnové mýdlo**
Foam soap/Schaumseife/Пенное мыло
-  **Tekutá dezinfekce**
Liquid disinfection/Flüssige Desinfektion
жидкая дезинфекция
-  **S dávkovačem tekutého mýdla**
With liquid soap dispenser/Mit Flüssigseifenspender
С дозатором жидкого мыла

-  **Mat**
Mat/Gebürstet/Mat
-  **Lesk**
Polished/Poliert/Блеск
-  **Černý**
Black/Schwarz/черный
-  **Bílý**
White/Weiß/Белый
-  **Bronz**
Bronze/Bronze/Бронза
-  **Zrcadlo**
Mirror/Spiegel/Зеркало
-  **Zámek**
Lock/Sperren/Замок
-  **Bílý kartáč**
White brush/weiße Bürste/Белая щётка
-  **Černý kartáč**
Black brush/schwarze Bürste/черная щётка
-  **Produkt je opatřený lepicí páskou, nevrťá se.**
The product is provided with adhesive tape,
it does not drill.
Das Produkt ist mit Klebeband ausgestattet,
bohrt nicht.
Изделие снабжено скотчем, без сверления.

Použitý materiál

Used material/Gebrauchtes Material/Используемый материал

304

Kartáčovaná nerez - základní materiál použitý k výrobě nerezových produktů. Určeno k vnitřnímu i venkovnímu použití v běžných podmínkách. Záruka 6 let za podmínek údržby uvedených v reklamačním řádu.

Brushed stainless steel - basic material used to manufacture stainless steel products. Intended for indoor and outdoor use in normal conditions.
6-year warranty under the maintenance conditions specified in the complaints procedure.

Gebürsteter Edelstahl - Grundmaterial zur Herstellung von Edelstahlprodukten. Zur Verwendung im Innen- und Außenbereich unter normalen Bedingungen vorgesehen. 6 Jahre Garantie unter den im Reklamationsverfahren angegebenen Wartungsbedingungen.

Шлифованная нержавеющая сталь марки 304 является основным материалом для производства изделий из нержавеющей стали. Предназначено для использования внутри и вне помещений в обычных климатических условиях.

Гарантийный срок 6 лет при условии соблюдения правил использования и обслуживания в соответствии с Порядком предъявления претензий.

316

NA OBJEDNÁVKU.

Kartáčovaná nerez - určená pro kontakt s chemickými látkami. Lze použít např. v plaveckých areálech, nereaguje na chlór.

ON ORDER.

Brushed stainless steel - intended for contact with chemical substances. Can be used e.g. in swimming areas, does not react to chlorine.

AUF BESTELLUNG.

Gebürsteter Edelstahl - bestimmt für den Kontakt mit chemischen Substanzen. Einsetzbar z.B. in Schwimmbädern, reagiert nicht auf Chlor.

НА ЗАКАЗ.

Шлифованная нержавеющая сталь марки 316 более устойчива к коррозии и агрессивным средам. Подходит для использования в бассейнах или в районах с морским климатом, т.к. невосприимчива к воздействию хлора и солям морской воды.

Obsah

Content

Inhalt

Содержание

| | | | |
|---|----|--|----|
| DÁVKOVAČE MÝDLA/DEZINFEKCE | 5 | NEREZOVÉ DOPLŇKY | 20 |
| Soap/disinfectant dispensers | | Stainless steel accessories | |
| Seifen-/Desinfektionsmittelspender | | Edestahl Zubehör | |
| Дозаторы мыла/дезинфицирующего средства | | Аксессуары из нержавеющей стали | |
| ZÁSOBNÍKY NA PAPIROVÉ KAPESNÍKY | 7 | Věšáčky na dveře | |
| Paper tissue dispensers | | Hooks for door/Türhaken/Крючки на дверь | |
| Spender für Papiertaschentücher | | Konzola pro umyvadlo uzavřená s držákem ručníků | |
| Диспенсеры для бумажных салфеток | | Washbasin console, rectangular | |
| ZÁSOBNÍKY HYGIENICKÝCH SÁČKŮ | 8 | Konsole für Waschbeckenplatte | |
| HygBag | | Кронштейн для умывальника | |
| HygBag-Spender | | с полотенцедержателем | |
| Диспенсеры для гигиенических пакетов | | Podstavec závěsný | |
| ZÁSOBNÍKY NA PAPIROVÉ RUČNÍKY | 9 | Hanging pedestal/Rahmen unter Waschtisch, hängend | |
| Hand towel dispensers | | Каркас под столешницу | |
| Papierhandtuchspender | | Sprchové poličky do spár | |
| Диспенсеры для бумажных полотенец | | Shower shelves/Duschablagen | |
| ZÁSOBNÍKY NA TOALETNÍ PAPIR | 10 | Полочки для душа | |
| Toilet paper dispensers | | Sprchové poličky | |
| Toilettenpapierspender | | Shower shelves/Duschregale/Полочки для душа | |
| Диспенсеры для туалетной бумаги | | Otvírák lahví | |
| DRŽÁKY TOALETNÍHO PAPIRU | 11 | Bottle opener/Flaschenöffner/Открывалка | |
| Toilet paper holders | | Polička na ručníky pětipatrová | |
| Toilettenpapierhalter | | Penta towel rack/5-fach Handtuchablage/ | |
| Держатели туалетной бумаги | | Настенный держатель полотенца | |
| WC ŠTĚTKY | 12 | Dveřní doraz na zem | |
| Toilet brushes | | Door stop on floor/Bodentürstopper/Дверной упор | |
| WC-Bürsten | | напольный | |
| Ёршики для унитаза | | Dveřní doraz na zeď | |
| ZÁSTĚNY MEZI PISOÁRY | 13 | Door stop on wall/Wandtürstopper/Дверной упор | |
| Urinal partitions | | настенный | |
| Urinal-Trennwände | | Ikony | |
| Перегородки между писсуарами | | Icons/Symbole/Таблички | |
| ODPAKOVÉ KOŠE | 14 | Sprchový program | |
| Waste bins | | Shower program/Duschprogramm/Душевое | |
| Abfalleimer | | оборудование | |
| Контейнеры для мусора | | Niva | |
| BEZDOTYKOVÉ OSOUŠEČE RUKOU | 18 | Neo | |
| Automatic hand dryers | | Easy | |
| Automatische Händetrockner | | BEZBARIÉROVÉ BYDLENÍ - HELP PROGRAM | 33 |
| Автоматические сушилки для рук | | Products for disabled people - HELP program | |
| ZRCADLA | 19 | Barrierefreies Wohnen - HELP-Programm | |
| Mirrors/ | | Безбарьерная среда - HELP программа | |
| Spiegel/ | | DESIGN NA ZAKÁZKU | 36 |
| Зеркала | | Products on order | |
| | | Maßgefertigtes Design | |
| | | Индивидуальный дизайн | |
| | | VESTAVNÉ WC BOXY | 37 |
| | | Bathroom built-in unit | |
| | | Badezimmer Wandeinbaumodule | |
| | | Встраиваемые модули для туалета | |
| | | VESTAVNÉ POLICE Z NERZOVÉ OCELI DO NIKY | 34 |
| | | Built-in st. steel containers | |
| | | Edelstahl Wandeinbaunische | |
| | | Встраиваемые в нишу полки из нерж. стали | |

Řadu NEREZ tvoří sortiment nepostradatelných koupelnových produktů, které se nesou v duchu maximálního minimalismu. Pokud hledáte designové doplňky splňující nejmodernější požadavky na vzhled i odolnost, s touto sérií vybavíte jakýkoliv prostor!

The STAINLESS series consists of an assortment of indispensable bathroom products, created in the spirit of maximal minimalism. If you're in search of high quality design accessories, which have meet the latest requirements for appearance and durability, then with this series you will be able to equip any bathroom space!

Produktlinie EDELSTAHL besteht aus einem Sortiment unverzichtbarer Badezimmerprodukte, welche im Geiste des maximalen Minimalismus geschaffen wurden. Wenn Sie Design-Accessoires suchen, die modernsten Anforderungen an Optik und Langlebigkeit gerecht werden, können Sie mit dieser Serie jeden Raum ausstatten!

Коллекция NEREZ представляет собой ассортимент товаров, необходимых для ваннх комнат, выполненных в духе максимального минимализма. Если вы ищете стильные аксессуары, отвечающие современным требованиям к внешнему виду и долговечности, с этой коллекцией вы сможете обустроить любое помещение!



Dávkovače mýdla/dezinfekce

Soap/disinfectant dispensers

Seifen-/Desinfektionsmittelspender

Дозаторы мыла/дезинфицирующего средства



101009415

123×336×115 mm



106109085

110×240×85 mm



123109013

123209013

100×320×110 mm



101109285

100×335×195 mm



101409171

100×320×110 mm



105109335

105109345

142×268×102 mm



124109265

124109335

140×235×102 mm



106109091

100×150×105 mm



| | 101009415 | 106109085 | 123109013 | 123209013 | 101109285 | 101409171 | 105109335 | 105109345 | 124109265 | 124109335 | 106109091 |
|--|-----------|-----------|-----------|-----------|-----------|-----------|--------------|-----------|-----------|-----------|-----------|
| Instalace Installation/Installation/Установка | | | | | | | | | | | |
| Povrchová úprava Finish/Ausführung/Поверхность | | | | | | | | | | | |
| Ovládání Control/Kontrolle/Управление | | | | | | | | | | | |
| Médium Medium/Medium/Назначение | LS | LS | LS | LS | LS | LS | LS DG | FS | LS | LD | LS |
| Objem Volume/Volumen/Объем | 1 100 ml | 800 ml | 1 100 ml | 1 100 ml | 1 000 ml | 1 100 ml | 1 100 ml | 1 100 ml | 1 200 ml | 1 200 ml | 500 ml |
| Zámek Lock/Sperren/Замок | | | | | | | | | | | |
| Napájení Power/Strom/ Питание | | | | | | | | | | | |



105109020
105109025
97×150×93 mm



105109035
107×180×98 mm



105109075
125×210×110 mm



105109205
80×180×105 mm



105109015
240×140×150 mm



141109195
100×220×113



137209155
70×175×120 mm



151109015
125×240×100



152109371
110×212×72 mm



152109381
136×212×72 mm



| | 105109020 | 105109025 | 105109035 | 105109075 | 105109205 | 105109015 | 141109195 | 137209155 | 151109015 | 152109371 | 152109381 |
|--|-----------|-----------|-----------|-----------|-----------|-----------|-----------|-----------|-----------|-----------|-----------|
| Instalace Installation/Installation/Установка | | | | | | | | | | | |
| Povrchová úprava Finish/Ausführung/Поверхность | | | | | | | | | | | |
| Ovládání Control/Kontrolle/Управление | | | | | | | | | | | |
| Médium Medium/Medium/Назначение | | | | | | | | | | | |
| Objem Volume/Volumen/Объем | 500 ml | 500 ml | 850 ml | 1 250 ml | 1 500 ml | 1 000 ml | 700 ml | 250 ml | 350 ml | 250 ml | 2×250 ml |
| Zámek Lock/Sperren/Замок | | | | | | | | | | | |
| Napájení Power/Strom/Питание | | | | | | | | | | | |

Zásobníky na papírové kapesníky

Paper tissue dispensers

Spender für Papiertaschentücher

Диспенсеры для бумажных салфеток



101003025

273×123 ×78 mm



102303020

102303021

102303025

250×130×75 mm



113103021

300×160×60 mm



134203022

200×120×110 mm



| | 101003025 | 102303020 | 102303021 | 102303025 | 113103021 | 134203022 |
|--|-----------|-----------|-----------|-----------|-----------|-----------|
| Instalace Installation/Installation/Установка | | | | | | |
| Povrchová úprava Finish/Ausführung/Поверхность | | | | | | |
| Zámek Lock/Sperren/Замок | | | | | | |

Zásobníky hygienických sáčků

HygBag

HygBag-Spender

Диспенсеры для гигиенических пакетов



101403031
101403035
95×145×30 mm



101403091
101403094
101403095
120×240×32 mm



101403130
101403131
101403134
101403135
92×131×24 mm

101003215

252×138×88 mm

Zásobník hygienických rukavic

Disposable gloves dispenser

Handschuhspender

Диспенсер для одноразовых перчаток



| | 101403031 | 101403035 | 101403091 | 101403094 | 101403095 | 101403130 | 101403131 | 101403134 | 101403135 | 101003215 |
|--|-----------|-----------|-----------|-----------|-----------|-----------|-----------|-----------|-----------|-----------|
| Instalace Installation/Installation/Установка | | | | | | | | | | |
| Povrchová úprava Finish/Ausführung/Поверхность | | | | | | | | | | |

Zásobníky na papírové ručníky

Hand towel dispensers

Papierhandtuchspender

Диспенсеры для бумажных полотенец



101003045
265×192×120 mm



101003205
384×336×115 mm



101003235
265×192×120 mm
101003275
265×375×120 mm



101003245
298×448×124 mm



101003255
298×448×124 mm



101003265
400×455×140 mm



113103041
113103045
270×375×115 mm



113103030
113103031
113103035
270×265×115 mm



| | 101003045 | 101003205 | 101003235 | 101003275 | 101003245 | 101003255 | 101003265 | 113103041 | 113103045 | 113103030 | 113103031 | 113103035 |
|--|-----------|-----------|-----------|-----------|-----------|-----------|-----------|-----------|-----------|-----------|-----------|-----------|
| Instalace Installation/Installation/Становка | | | | | | | | | | | | |
| Povrchová úprava Finish/Ausführung/Поверхность | | | | | | | | | | | | |
| Ovládání Control/Kontrolle/Управление | | | | | | | | | | | | |
| Médium Medium/Medium/Назначение | | LS | | | | | LS | | | | | |
| Objem Volume/Volumen/Объем | | 1 100 ml | | | | | 1 100 ml | | | | | |
| Zámek Lock/Sperren/Замок | | | | | | | | | | | | |

Zásobníky na toaletní papír

Toilet paper dispensers
 Toilettenpapierspender
 Диспенсери для туалетной бумаги



101003225
 173×78×145 mm



101003165
 130×679×120 mm



148212051
148212055
 260×282×117 mm



148312081
148312085
 310×325×128 mm



148112050
148112051
148112055
 200×215×117 mm

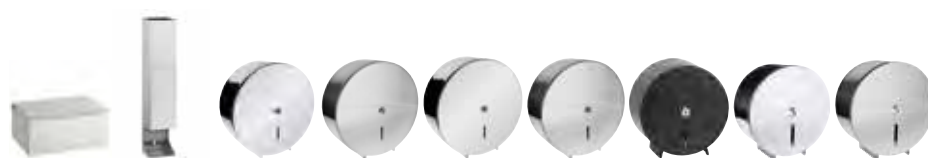

| | 101003225 | 101003165 | 148212051 | 148212055 | 148312081 | 148312085 | 148112050 | 148112051 | 148112055 |
|--|-----------|-----------|-----------|-----------|-----------|-----------|-----------|-----------|-----------|
| Instalace Installation/Installation/Установка | | | | | | | | | |
| Povrchová úprava Finish/Ausführung/Поверхность | | | | | | | | | |
| Zámek Lock/Sperren/Замок | | | | | | | | | |

Držáky toaletního papíru

Toilet paper holders
 Toilettenpapierhalter
 Держатели туалетной бумаги



101012175
 205×135×147 mm



101012015
 143×111×90 mm



101012185
 243×111×90 mm



105112315
 140×80/190×100 mm

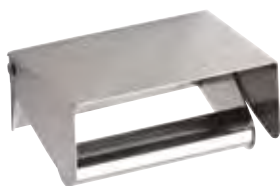

146212011
 133×67×105 mm



153312132
 180×77×93 mm



101012045
 254×53×67 mm



146212245
 320×30×90 mm

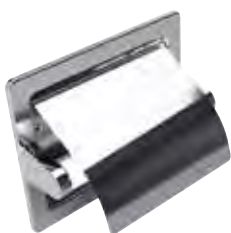

105112121
 155×130×80 mm



134103012
 200×60×100 mm



| | 101012175 | 101012015 | 101012185 | 105112315 | 146212011 | 153312132 | 101012045 | 146212245 | 105112121 | 134103012 |
|--|-----------|-----------|-----------|-----------|-----------|-----------|-----------|-----------|-----------|-----------|
| Instalace Installation/Installation/Установка | | | | | | | | | | |
| Povrchová úprava Finish/Ausführung/Поверхность | | | | | | | | | | |

WC štětky

Toilet brush holders

WC-Bürsten

Ёршики для унитаза



101013175
148×448×129 mm



101113091
115×370×110 mm



101113335
110×400×115 mm



102313065
102313069
95×390×105 mm



102313075
102313079
90×380×115 mm



163113060
163113061
163113065
80×355×97 mm



| | 101013175 | 101113091 | 101113335 | 102313065 | 102313069 | 102313075 | 102313079 | 163113060 | 163113061 | 163113065 |
|--|-----------|-----------|-----------|-----------|-----------|-----------|-----------|-----------|-----------|-----------|
| Instalace Installation/Installation/Установка | | | | | | | | | | |
| Povrchová úprava Finish/Ausführung/Поверхность | | | | | | | | | | |
| Kartáč Brush/Bürste/Щётка | | | | | | | | | | |

Zástěny mezi pisoáry

Urinal partitions

Urinal-Trennwände

Перегородки между писсуарами



101042065
60×860×400 mm



101042075
30×800×390 mm



| | 101042065 | 101042075 |
|--|-----------|-----------|
| Instalace Installation/Installation/Установка | | |
| Povrchová úprava Finish/Ausführung/Поверхность | | |

Odpadkové koše

Waste bins
Abfalleimer
Контейнеры для мусора



101015315

170×42×170 mm, ø 135 mm

Vhoz kulatý k zabudování do desky

Countertop-mounted circular waste chute

Durchwurfring zum Einbau

Люк для мусора круглый, встраиваемый



101015335

300×105×30 mm

Vhoz k zabudování do desky

Countertop-Mounted lid trash bin cover

Quadratischer Abfallschacht zum Einbau

Люк для мусора прямоугольный, встраиваемый



101015295

298×448×170 mm



101015305

298×448×170 mm



101015325

300×450×130 mm



101015345

226×570×130 mm



101015355

300×560×330 mm



105115055

190×265×90 mm



| | 101015315 | 101015335 | 101015295 | 101015305 | 101015325 | 101015345 | 101015355 | 105115055 |
|--|-----------|-----------|-----------|-----------|-----------|-----------|-----------|-----------|
| Instalace Installation/Installation/Становка | ■ | ■ | ■ | ■ | ■ | ■ | ■ | ■ |
| Povrchová úprava Finish/Ausführung/Поверхность | ■ | ■ | ■ | ■ | ■ | ■ | ■ | ■ |
| Objem volume/Volumen/Объем | | | 6,5 l | 21 l | 4 l | 4 l | 45 l | 5 l |
| Vnitřní nádoba Inner container/Innenbehälter/Внутреннее ведро | | | ✓ | ✓ | ✓ | ✓ | ✓ | ✓ |
| Zásobník hygienických sáčků Storage of sanitary bags/Hygienebeutelspender/Хранение гигиенических пакетов | | | ✓ | | ✓ | ✓ | | |



101915050
101915051
101915054
101915055
 205×300×100 mm



101915110
101915111
101915115
 250×500×250 mm



101915121
101915125
 300×600×250 mm



101915131
101915135
 350×750×250 mm



125115041
125115045
 370×460×165 mm

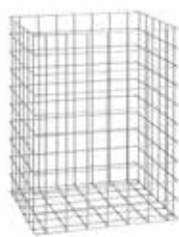

101015065
 353×503×305 mm



101015365
 455×603×255 mm



115115031
115115035
 200×270×200 mm



| | 101915050 | 101915051 | 101915054 | 101915055 | 101915110 | 101915111 | 101915115 | 101915121 | 101915125 |
|---|-----------|-----------|-----------|-----------|-----------|-----------|-----------|-----------|-----------|
| Instalace Installation/Installation/Установка | | | | | | | | | |
| Povrchová úprava Finish/Ausführung/Поверхность | | | | | | | | | |
| Objem volume/Volumen/Объем | 6 l | 6 l | 6 l | 6 l | 25 l | 25 l | 25 l | 45 l | 45 l |
| Vnitřní nádoba Inner container/Innenbehälter/ Внутреннее ведро | ✓ | ✓ | ✓ | ✓ | | | | | |

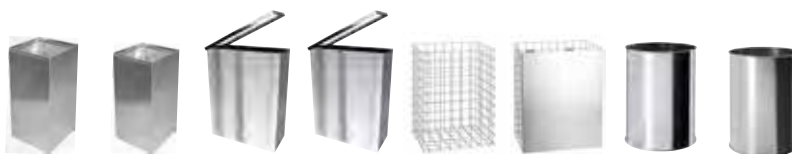

| | 101915131 | 101915135 | 125115041 | 125115045 | 101015065 | 101015365 | 115115031 | 115115035 |
|--|-----------|-----------|-----------|-----------|-----------|-----------|-----------|-----------|
| Instalace Installation/Installation/Установка | | | | | | | | |
| Povrchová úprava Finish/Ausführung/Поверхность | | | | | | | | |
| Objem volume/Volumen/Объем | 75 l | 75 l | 25 l | 25 l | 52 l | 67 l | 9 l | 9 l |



125115051
125115055
170×235×240 mm



104315010
104315014
205×280×205 mm



104315023
170×260×170 mm



104315022
104315025
170×255×170 mm



104315012
104315052
200×280×200 mm



104315032
250×390×250 mm



104315082
300×450×300 mm



104315092
300×650×300 mm



| | 125115051 | 125115055 | 104315010 | 104315014 | 104315023 | 104315022 |
|---|-----------|-----------|-----------|-----------|-----------|-----------|
| Instalace Installation/Installation/Установка | | | | | | |
| Povrchová úprava Finish/Ausführung/Поверхность | | | | | | |
| Objem volume/Volumen/Объем | 3 l | 3 l | 5 l | 5 l | 3 l | 3 l |
| Vnitřní nádoba Inner container/Innenbehälter/Внутреннее ведро | | | | | | |
| Soft Close | | | | | | |



| | 104315025 | 104315012 | 104315052 | 104315032 | 104315082 | 104315092 |
|---|-----------|-----------|-----------|-----------|-----------|-----------|
| Instalace Installation/Installation/Установка | | | | | | |
| Povrchová úprava Finish/Ausführung/Поверхность | | | | | | |
| Objem volume/Volumen/Объем | 3 l | 5 l | 5 l | 12 l | 20 l | 30 l |
| Vnitřní nádoba Inner container/Innenbehälter/Внутреннее ведро | | | | | | |



104315102
350×650×350 mm



125115071
200×300×200 mm



137115225
240×340×240 mm



137115205
120×155×120 mm



150115151
150115161
250×295×250 mm



137115215
450×755×430 mm



137115165
400×490×320 mm



104315262
590×435×375 mm



104315272
590×435×375 mm



| | 104315102 | 125115071 | 137115225 | 137115205 | 150115151 | 150115161 | 137115215 | 137115165 | 104315262 | 104315272 |
|--|-----------|-----------|-----------|-----------|-----------|-----------|-----------|-----------|-----------|-----------|
| Instalace Installation/Installation/Установка | ● | ● | ● | ● | ● | ● | ● | ● | ● | ● |
| Povrchová úprava Finish/Ausführung/Поверхность | ■ | ■ | ■ | ■ | ■ | ■ | ■ | ■ | ■ | ■ |
| Objem volume/Volumen/Объем | 40 l | 6 l | 9 l | 1,5 l | 7,5 l | 7,5 l | 90 l | 2×15 l | 3×14 l | 2×20 l |
| Vnitřní nádoba Inner container/Innenbehälter/Внутреннее ведро | | ✓ | ✓ | | | | | 2× ✓ | 3× ✓ | 2× ✓ |
| Soft Close | | ✓ | | | | | | ✓ | ✓ | ✓ |
| Povrch odolný proti otiskům prstů Fingerprint resistant / Fingerabdrucksichere Oberfläche/Защита от отпечатков пальцев | | | ✓ | ✓ | | | ✓ | ✓ | ✓ | ✓ |

Bezdotykové osoušeče rukou

Automatic hand dryers

Automatische Händetrockner

Автоматические сушилки для рук



924224150
924224155



170×255×100 mm, 700 W



924224141



260×230×195 mm, 2300 W



106224015
945224061

270×240×200 mm, 2500 W



924224131
924224135



173×255×150 mm, 1350 W



924224121



295×320×162 mm, 1800 W



924224111



290×325×105 mm, 1000 W



| | 924224150 | 924224155 | 924224141 | 106224015 | 945224061 | 924224131 | 924224135 | 924224121 | 924224111 |
|--|-----------|-----------|-----------|-----------|-----------|-----------|-----------|-----------|-----------|
| Instalace Installation/Installation/Установка | | | | | | | | | |
| Povrchová úprava Finish/Ausführung/Поверхность | | | | | | | | | |
| Jmenovitý příkon Rated power/Nennleistung/Номинальная мощность | 1000 W | 1000 W | 2 300 W | 2 500 W | 2 500 W | 1 350 W | 1 350 W | 1 800 W | 1 000 W |
| Frekvence Frequency/Frequenz/Частота | 50 Hz | 50 Hz | 50 Hz | 50/60 Hz | 50/60 Hz | 50/60 Hz | 50/60 Hz | 50/60 Hz | 50/60 Hz |
| Jmenovité napětí Feeding tension/Nennspannung/Номинальная мощность | 230 V | 230 V | 220-240 V | 220-240 V | 220-240 V | 220-240 V | 220-240 V | 220-240 V | 220-240 V |
| Max. rychlost vzduchu max. air speed/Max. Luftgeschwindigkeit/Макс. скорость воздушного потока | 100 m/s | 100 m/s | 26 m/s | 30 m/s | 30 m/s | 100 m/s | 100 m/s | 100 m/s | 100 m/s |
| Hlučnost Noise/Lärm/Уровень шума | 70 dB | 70 dB | 70 dB | 85 dB | 85 dB | 70 dB | 70 dB | 74 dB | 70 dB |
| Třída izolace Insulation class/Isolationsklasse/Степень пылевлагозащиты | IP 23 | IP 23 | X1 | IP 60 | IP 60 | X1 | X1 | X1 | X1 |
| Zapojení do zásuvky Connecting to a socket/Anschluss an eine Steckdose/Подключение к розетке | ✓ | ✓ | ✓ | ✓ | ✓ | ✓ | ✓ | ✓ | ✓ |

Zrcadla

Mirrors
Spiegel
Зеркала



101301652
600×800 mm



301401041
301401042
301401044
600×600 mm



301401030
301401031
301401032
301401034
600×400 mm



| | 101301652 | 301401041 | 301401042 | 301401044 | 301401030 | 301401031 | 301401032 | 301401034 |
|---|-----------|-----------|-----------|-----------|-----------|-----------|-----------|-----------|
| Instalace Installation/Installation/Установка | | | | | | | | |
| Povrchová úprava Finish/Ausführung/Поверхность | SUPER | | | | | | | |
| Výklopné Tilting/Клосpiegel/Поверотно-откидыв. механизм | | | | | | | | |

Nerezové doplňky

Stainless steel accessories

Edestahl Zubehör

Аксессуары из нержавеющей стали

Věšáčky na dveře

Hook for door/Türhaken/Крючки на дверь



101106150
101106154
101106155
25×85×34 mm



101106220
101106224
101106225
175×87×34 mm



101106230
101106234
101106235
350×87×34 mm

Konzola pro umyvadlo uzavřená s držákem ručníků

Washbasin console, rectangular/Konsole für Waschbeckenplatte/Kронштейн для умывальника с полотенцедержателем

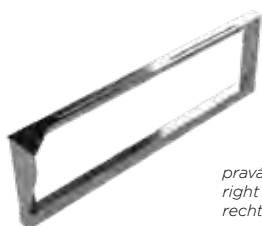

pravá
right
rechts
правый

201541060
201541061
201541064
201541065
56×150×490 mm, 50 kg



levá
left
links
левый

201541050
201541051
201541054
201541055
56×150×490 mm, 50 kg



| | | | | | | |
|--|-----------|-----------|-----------|-----------|-----------|-----------|
| 101106150 | 101106154 | 101106230 | 201541060 | 201541061 | 201541064 | 201541065 |
| 101106220 | 101106224 | 101106225 | 201541050 | 201541051 | 201541054 | 201541055 |
| 101106230 | 101106234 | 101106235 | | | | |
| Povrchová úprava Finish/Ausführung/Поверхность | ■ | □ | ■ | ■ | □ | ■ |

Podstavec závěsný

Hanging pedestal/Rahmen unter Waschtisch, hängend/Каркас под столешницу, подвесной

**Zakázková výroba.****Rozměr a povrchová úprava dle požadavků zákazníka**

Products on order.

Dimension and finish according to customer requirements

Kundenspezifische Produktion.

Dimension und Ausführung nach Kundenwunsch

Изготовление под заказ.

Размеры и поверхностная обработка по индивидуальному запросу заказчика.



Sprchové poličky do spár

Shower shelves/Duschablagen/Полочки для душа



101302400
101302401
101302405
 300×2×135 mm



101302410
101302411
101302415
 300×15×135 mm



101302420
101302421
101302425
 297×2×210 mm



101302430
101302431
101302435
 297×15×210 mm



101302440
101302441
101302445
 297×2×210 mm



101302450
101302451
101302455
 297×15×210 mm

Sprchové poličky

Shower shelves/Duschregale/Полочки для душа



102308080
102308081
 300×26×115 mm



102308051
 205×25×110 mm



102308260
102308261
102308264
 262×35×142 mm



102308061
 311×45×210 mm



| | | | | | | | | | | |
|-----------|-----------|-----------|-----------|-----------|-----------|-----------|-----------|-----------|-----------|--|
| 101302400 | 101302401 | 101302405 | | | | | | | | |
| 101302410 | 101302411 | 101302415 | | | | | | | | |
| 101302420 | 101302421 | 101302425 | 102308080 | 102308081 | 102308051 | 102308260 | 102308261 | 102308264 | 102308061 | |
| 101302430 | 101302431 | 101302435 | | | | | | | | |
| 101302440 | 101302441 | 101302445 | | | | | | | | |
| 101302450 | 101302451 | 101302455 | | | | | | | | |

Povrchová úprava
 Finish/Ausführung/Поверхность



Sprchové poličky

Shower shelves/Duschregale/Полочки для душа



146208016
305×55×220 mm



146208036
300×55×125 mm



102308216
315×67×235 mm



153102390
290×47×220 mm



102308241
305×380×115 mm

Otvírák lahví

Bottle opener/Flaschenöffner/Открывалка



101832011
45×65×40 mm

Polička na ručníky pětipatrováPenta towel rack/5-fach Handtuchablage
Настенный держатель полотенец

101302182
150×265×120 mm

Dveřní doraz na zemDoor stop on floor/Bodentürstopper/Дверной упор
напольный

101218010
101218012
101218015
101218017
33×30×33 mm

Dveřní doraz na zeďDoor stop on wall/Wandtürstopper/Дверной упор
настенный

101218020
101218022
101218025
101218027
33×30×33 mm



| | | | | | | | | | | | |
|--|-----------|-----------|-----------|-----------|-----------|-----------|-----------|------------------------|------------------------|------------------------|------------------------|
| | 146208016 | 146208036 | 102308216 | 153102390 | 102308241 | 101832011 | 101302182 | 101218010 101218020 | 101218012 101218022 | 101218015 101218025 | 101218017 101218027 |
| Povrchová úprava Finish/Ausführung/Поверхность | ■ | □ | ■ | ■ | ■ | ■ | ■ | ■ | ■ | ■ | ■ |

Ikony

Icons/Symbole/Таблички



111022062
111022065

120×120×2 mm

Přebalovna

Baby nursery room

Wickelraum

Помещение для
переодевания детей



111022012
111022015

120×140×2 mm

Kouření povoleno

Smoking

Rauchen gestattet

Место для курения



111022052
111022055

120×140×2 mm

Zákaz kouření

No smoking

Rauchen verboten

Куриль запрещено



111022032
111022035

120×130×2 mm

WC páni

Gentlemen toilet

WC Herren

Мужской туалет



111022042
111022045

120×130×2 mm

WC dámy

Ladies toilet

WC Damen

Женский туалет



111022022
111022025

120×130×2 mm

WC vozíčkář

Disabled toilets

Behinderte

Туалет для инвалидов



111022082
111022085

120×120×2 mm

WC

WC

WC

WC



111022072
111022075

120×120×2 mm

Sprcha

Showers

Duschen

Душевая



111022092
111022095

120×120×2 mm

Úklidová místnost

Cleaning room

Putzraum

Подсобное помещение



108022072
108022075

80×35×2 mm

WC

WC

WC

WC



108022062
108022065

40×85×2 mm

WC dámy

Ladies toilet

WC Damen

Женский туалет



108022052
108022055

40×85×2 mm

WC páni

Gentlemen toilet

WC Herren

Мужской туалет

| | Povrchová úprava Finish/Ausführung/Поверхность | Instalace Installation/Installation/Установка |
|------------|--|---|
| XXXXXXXX-2 | | |
| XXXXXXXX-5 | | |

Ikony

Icons/Symbole/Таблички

**111054003 - A**

75×75×2 mm

Přebalovna

Baby nursery room

Wickelraum

Помещение для
переодевания детей**111054021 - A**

75×75×2 mm

Kouření povoleno

Smoking

Rauchen gestattet

Место для курения

**111054022 - A**

75×75×2 mm

Zákaz kouření

No smoking

Rauchen verboten

Курить запрещено

**111054002 - A**

75×75×2 mm

WC páni

Gentlemen toilet

WC Herren

Мужской туалет

**111054007 - A**

75×75×2 mm

WC dámy

Ladies toilet

WC Damen

Женский туалет

**111054072 - A**

75×75×2 mm

Ženy a muži

Man and woman

Damen und Herren

Для мужчин
и женщин**111054001 - A**

75×75×2 mm

WC vozíčkář

Disabled toilets

Behinderte

Туалет для
инвалидов**111054006 - A**

75×75×2 mm

WC

WC

WC

WC

**111054004 - A**

75×75×2 mm

Sprcha

Showers

Duschen

Душевая

**111054005 - A**

75×75×2 mm

Úklidová místnost

Cleaning room

Putzraum

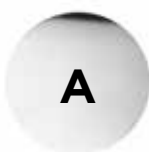
Подсобное
помещение**A****kruh, lesk**circle, polished
rund, glänzend
круг, блеск**C****čtverec, lesk**square, polished
quadratisch, glänzend
квадрат, блеск**B****kruh, mat**circle, matt
rund, matt
круг, мат**D****čtverec, mat**square, matt
quadratisch, matt
квадрат, мат**Instalace**
Installation/Installation/Установка

A, B, C, D

**Kompletní nabídka informačních tabulek: www.bemeta.cz**Complete offer of icons: [www.bemeta.cz/Komplettes Angebot](http://www.bemeta.cz/Komplettes>Angebot) an Informationstafeln: www.bemeta.cz/Полное предложение информационных табличек: www.bemeta.cz.

Sprchový program

Shower program/Duschprogramm/Душевое оборудование

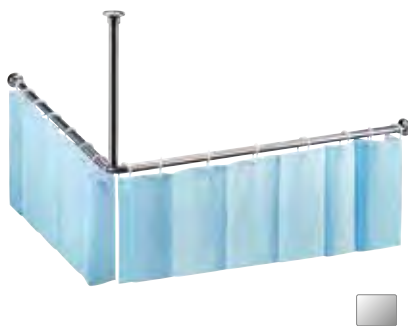

101114361

ø 25 mm, 900×55×55 mm

101120012

ø 25 mm, 1 000×55×55 mm

101120022

ø 25 mm, 1 500×55×55 mm

101120032

ø 25 mm, 2 000×55×55 mm

Tyč sprchového závěsu*

Shower curtain holder*

Duschvorhangstange*

Карниз для душа*

101120042

ø 25 mm, 900×500×900 mm

101120052

ø 25 mm, 1 400×500×1 400 mm

Tyč sprchového závěsu, rohová*

Shower curtain holder, corner model*

Eckduschvorhangstange*

Угловой карниз для душа*



101120071

ø 25 mm, 900×60×60 mm

101120081

ø 25 mm, 1 000×60×60 mm

101120091

ø 25 mm, 1 500×60×60 mm

101120101

ø 25 mm, 2 000×60×60 mm

Tyč sprchového závěsu, skládaná*

Shower curtain holder, folding*

Duschvorhangstange, steckbar*

Карниз для душа, разборный*

101120111

ø 25 mm, 900×500×900 mm

101120231

ø 25 mm, 1 300×500×1 300 mm

101120121

ø 25 mm, 1 400×500×1 400 mm

Tyč sprchového závěsu rohová, skládaná*

Shower curtain holder, corner model, folding*

Duschvorhangstange steckbar*

Угловой карниз для душа, разборный*



101120110

ø 25 mm, 900×500×900 mm

Tyč sprchového závěsu rohová, skládaná*

Shower curtain holder, corner model, folding*

Duschvorhangstange steckbar*

Угловой карниз для душа, разборный*

* Tyče dodáváme bez sprchového závěsu.

* The rods are supplied without a shower curtain./Die Stange liefern wir ohne Duschvorhang.
Занавеска для душа в комплект не входит.

Sprchový program

Shower program/Duschprogramm/Душевое оборудование

Objednejte si skládanou tyč sprchového závěsu na míru

Assemble your custom shower curtain holder from our components.
Bestellen Sie steckbare Duschvorhangstange, wunschgemäß angepasst.
Вы можете заказать карниз для душа, составленный из необходимых элементов

Fixační tyč do stropu

Ceiling anchor tube
Befestigung Deckenrohr
Потолочный кронштейн

Trubka

Tube
Rohr
Труба

Spojka pro trubky

Fitting
Rohrverbinder
Соединительная муфта для труб

Příruba s krytkou

Flange with cover
Flansch mit Rosette
Фланец с крышкой

Koleno 90°

Elbow 90°
Ellenbogen 90°
Труба угловая 90°

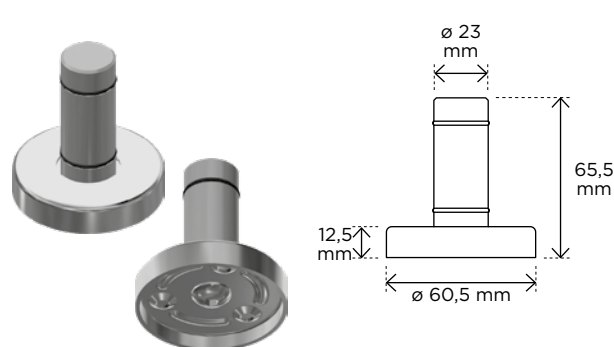
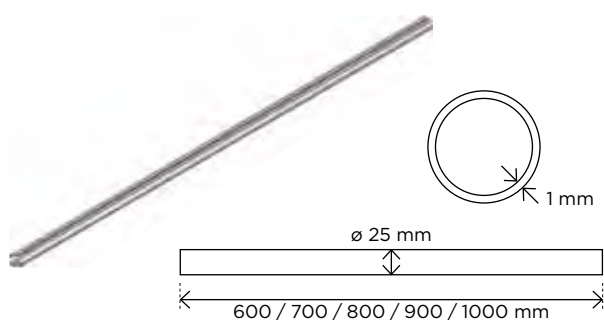

| Trubka | |
|-----------------|------------------|
| Tube/Rohr/Труба | |
| 600 mm | 101120162 |
| 700 mm | 101120172 |
| 800 mm | 101120182 |
| 900 mm | 101120192 |
| 1000 mm | 101120202 |
| 1170 mm | 101120271 |

101120132

Příruba s krytkou, včetně montážního balíčku

Flange with cover, including assembly package

Flansch mit Rosette, inkl. Montagepaket

Фланец с крышкой, вкл. крепёж

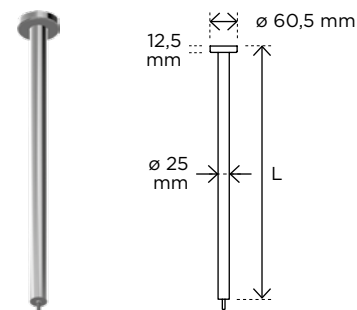
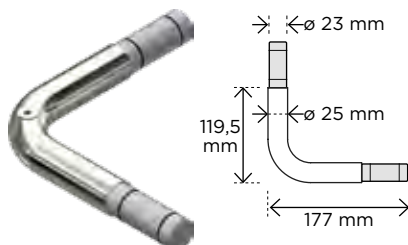
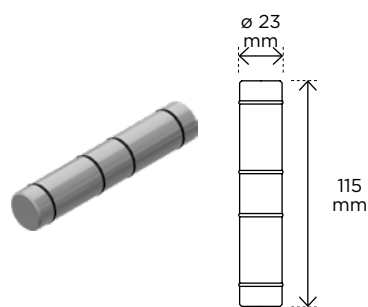

101120152

Spojka pro trubky

Fitting

Rohrverbinder

Соединительная муфта для труб

101120222

Koleno 90° + 2× spojka

Elbow 90° + 2× fitting

Ellenbogen 90° + 2× Rohrverbinder

Труба угловая 90° + 2× Соединительная муфта

Fixační tyč do stropu

Ceiling anchor tube/Befestigung Deckenrohr/Потолочный кронштейн

300 mm **101120241**

500 mm **101120142**

800 mm **101120251**

1200 mm **101120261**

NIVA



101106035

48×85×22 mm

Háček dvojitý

Double robe hook

Doppelkleiderhaken

Крючок двойной

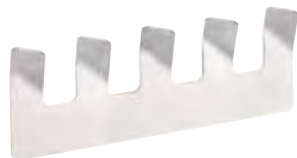

101106045

180×70×22 mm

Věšák s 5 háčky

Hanger, 5 hooks

Hakenleiste mit 5 Haken

Планка с 5 крючками



101106025

155×57×80 mm

Držák toaletního papíru

Paper holder

Papierrollenhalter

Держатель туалетной бумаги



101104015

270×57×80 mm

Držák toaletního papíru s poličkou

Toilet paper holder with shelf

Toilettenpapierhalter mit Ablage

Держатель туалетной бумаги с полочкой



101102365

180×50×97 mm

Polička

Shelf

Handtuchablage

Полочка



101102225

300×50×97 mm

Polička

Shelf

Handtuchablage

Полочка



101112135

335×50×70 mm

Držák ručníků

Towel holder

Handtuchhalter

Полотенцедержатель



101109225

66×165×120 mm, 300 ml

Dávkovač mýdla

Soap dispenser

Seifenspender

Дозатор мыла



101109095

66×235×120 mm, 500 ml

Dávkovač mýdla

Soap dispenser

Seifenspender

Дозатор мыла



101113091

130×353×120 mm

WC štětka na zavěšení

Wall mounted toilet brush holder

WC - Bürstengarnitur hängend

Ёршик подвесной

Neo



104106065

55×55×55 mm

Háček

Single robe hook

Kleiderhaken

Крючок



104106025

55×55×50 mm

Háček

Single robe hook

Kleiderhaken

Крючок



104106035

55×55×50 mm

Háček dvojitý

Double robe hook

Doppelkleiderhaken

Крючок двойной



104106165

ø 16×50 mm

104506095

ø 16×30 mm

Háček

Single robe hook

Kleiderhaken

Крючок



104112015

135×155×90 mm

Držák toaletního papíru s krytem

Paper holder with cover

Papierrollenhalter mit Deckel

Держатель туалетной бумаги с крышкой



104112045

135×120×98 mm

Držák toaletního papíru bez krytu

Paper holder without cover

Papierrollenhalter ohne Deckel

Держатель туалетной бумаги без крышки

levý
left
links
левый



104112045R

135×120×98 mm

Držák toaletního papíru bez krytu

Paper holder without cover

Papierrollenhalter ohne Deckel

Держатель туалетной бумаги без крышки

pravý
right
rechts
правый



104212035

175×55×70 mm

Držák toaletního papíru

Paper holder

Papierrollenhalter

Держатель туалетной бумаги



104112035

55×165×65 mm

Držák toaletního papíru rezervní

Spare toilet paper holder

Reservepapierrollenhalter

Держатель запасного рулона



104113105*

104113109**

110×400×130 mm

WC štětka na postavení

Toilet brush holder, free standing

WC-Bürstengarnitur mit Glasbehälter, Standmodell

Ёршик напольный



104113015*

104113019**

115×360×130 mm

WC štětka

Wall mounted toilet brush holder

WC-Bürstengarnitur mit Glasbehälter

Ёршик подвесной



102313075*

102313079**

90×380×115 mm

WC štětka

Wall mounted toilet brush holder

WC-Bürstengarnitur

Ёршик подвесной

* bílý kartáč/white brush/weiße Bürste/щётка белая. ** černý kartáč/black brush/schwarze Bürste/щётка черная



102313055*
102313059**

95×380×95 mm

WC štětka na postavení

Toilet brush holder,
free standing

WC-Bürstengarnitur,
stehend oder hängend

Ёршик напольный



102313065*
102313069**

95×390×105 mm

**WC štětka na postavení
nebo pověšení**

Toilet brush holder,
free standing or hanging

WC-Bürstengarnitur,
stehend oder hängend

Ёршик
подвесной/напольный



104109115

75×145×100 mm, 200 ml

Dávkovač mýdla

Soap dispenser

Seifenspender

Настенный дозатор мыла



104109016

80×190×133 mm, 230 ml

Dávkovač mýdla

Soap dispenser

Seifenspender

Настенный дозатор мыла



104109015

55×175×85 mm, 150 ml

Dávkovač mýdla

Soap dispenser

Seifenspender

Настенный дозатор мыла



104109035

70×230×110 mm, 550 ml

**Dávkovač tekutého mýdla
JUMBO**

Soap dispenser JUMBO

Seifenspender JUMBO

Настенный дозатор мыла
JUMBO



123209013

100 × 320 × 110 mm, 1
100 ml

Dávkovač mýdla

Soap dispenser

Seifenspender

Диспенсер мыла



104106153

20 × 70 × 40 mm

Háček na dveře

Robe hook

Türhaken

Крючок на дверь



104308172

230×30×130 mm

Polička do sprchy rohová

Corner shower shelf

Eckduschkorb

Душевая полочка,
угловая



104308072

230×30×120 mm

Polička do sprchy

Shower shelf

Duschregal

Душевая полка



102307015

355 × 55 × 75 mm

Madlo

Bath grab bar

Wannengriff

Поручень прямой

**104204105**

55×165×440 mm

Držák ručníků dvojitý otočný

Double swing arm towel holder

Doppelhandtuchhalter, schwenkbar

Полотенцедержатель двойной поворотный

**104205075**

655×110×215 mm

Polička na ručníky s hrazdou

Towel rack with rail

Handtuchablage

Полочка для полотенец с вешалкой

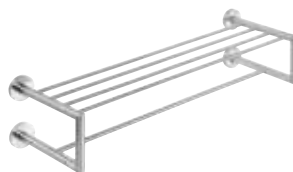
**104205105**

655×160×225 mm

Polička na ručníky dvojitá s hrazdou

Double towel rack with rail

Doppelhandtuchablage

Полочка для полотенец с вешалкой

**104204015**

355×55×65 mm

104204125

505×55×65 mm

104204125

655×55×65 mm

Držák ručníků

Towel holder

Handtuchhalter

Полотенцедержатель

**104204055**

655×55×125 mm

Držák ručníků dvojitý

Double towel holder

Doppelhandtuchhalter

Полотенцедержатель





easy



163106260 
163106261 
163106265 
 45×45×38 mm
Háček
 Single robe hook
 Kleiderhaken
 Крючок



163106360 
163106361 
163106365 
 45×45×31 mm
Háček
 Single robe hook
 Kleiderhaken
 Крючок



163106270 
163106271 
163106275 
 115×45×38 mm
Věšák se 2 háčky
 Hanger with 2 hooks
 Hakenleiste mit 2 Haken
 Планка с 2 крючками



163106370 
163106371 
163106375 
 115×45×31 mm
Věšák se 2 háčky
 Hanger with 2 hooks
 Hakenleiste mit 2 Haken
 Планка с 2 крючками



163106290 
163106291 
163106295 
 45×45×38 mm
Věšák se 4 háčky
 Hanger with 4 hook
 Hakenleiste mit 4 Haken
 Планка с 4 крючками



163106390 
163106391 
163106395 
 45×45×31 mm
Věšák se 4 háčky
 Hanger with 4 hook
 Hakenleiste mit 4 Haken
 Планка с 4 крючками



163112220 
163112221 
163112225 
 145×100×42 mm
Držák toaletního papíru
 Toilet paper holder
 Papierrollenhalter
 Держатель туалетной бумаги



163112020 
163112021 
163112025 
 145×100×42 mm
Držák toaletního papíru
 Toilet paper holder
 Papierrollenhalter
 Держатель туалетной бумаги





163112230 
163112231 
163112235 
 45×180×74 mm
Držák toaletního papíru rezervní
 Spare toilet papare holder
 Papierrollenhalter
 Держатель запасного рулона







163112030 
163112031 
163112035 
 45×180×74 mm
Držák toaletního papíru rezervní
 Spare toilet papare holder
 Papierrollenhalter
 Держатель запасного рулона



163113060 
163113061 
163113065 
 80×355×97 mm
WC štětka
 Wall mounted toilet brush holder
 WC-Bürstengarnitur
 Ёршик подвесной



163104040 
163104041 
163104045 
163104240 
163104241 
163104245 
 80×355×97 mm
Držák ručníků
 Towel holder
 Handtuchhalter
 Полотенцедержатель



Bezbariérové bydlení - HELP program

Products for disabled people - HELP program

Barrierefreies Wohnen - HELP-Programm

Безбарьерная среда - HELP программа

Možnosti provedení

Design possibilities/Ausführungsmöglichkeiten/Возможности изготовления

Povrchová úprava

Surface finish/Ausführung/Поверхность

lesk

polished/poliert/глянец



brus

brushed/gebürstet/шлиф



komaxit bílý

white/weiss/белый



komaxit černý

black/Schwarz/черный



Příruba s krytkou

Flange with cover/Flansch mit Rosette/Фланец с крышкой

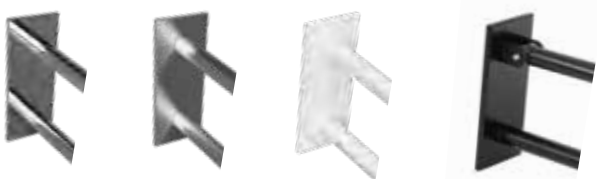

Příruba bez krytky

Flange without cover/Flansch ohne Rosette/Фланец без крышки



Produkty

Products/Produkte/Продукты

Madlo

Grab bar/Haltegriff/поручень

| | | |
|--------|--------|---------|
| 200 mm | 600 mm | 1000 mm |
| 300 mm | 700 mm | 1100 mm |
| 400 mm | 800 mm | 1200 mm |
| 500 mm | 900 mm | 1500 mm |



Podpěrné madlo ve tvaru U

Grab bar U-shaped/Stützgriff

U-Förmig/Опорный U-образный

| | |
|--------|--------|
| 600 mm | 850 mm |
| 750 mm | 900 mm |
| 813 mm | |



Podpěrné madlo ve tvaru U s držákem toaletního papíru

Grab bar U-shaped with toilet paper holder/Stützgriff U-Förmig mit Toilettenpapierhalter/Опорный U-образный поручень с держателем туалетной бумаги

| | |
|--------|--------|
| 600 mm | 850 mm |
| 750 mm | 900 mm |
| 813 mm | |



Sklopný úchyt ve tvaru U

Folding grab bar U-shaped/

Stützklappgriff/Откидной

U-образный поручень

| | |
|--------|--------|
| 600 mm | 850 mm |
| 750 mm | 900 mm |
| 813 mm | |



Sklopný úchyt ve tvaru U s držákem toaletního papíru

Folding grab bar U-shaped with

toilet paper holder/Stützklappgriff

mit Toilettenpapierhalter/Откидной

U-образный поручень с держателем

туалетной бумаги

| | |
|--------|--------|
| 600 mm | 850 mm |
| 750 mm | 900 mm |
| 813 mm | |



Sklopný úchyt

Folding grab bar/Stützklappgriff/
Откидной поручень

760 mm
850 mm



Sklopný úchyt s držákem toaletního papíru

Folding grab bar with toilet
paper holder/Stützklappgriff mit
Toilettenpapierhalter/Откидной
поручень с держателем туалетной
бумаги

760 mm
850 mm



**Sklopný úchyt ve tvaru U,
ukotvený do země**

Folding grab bar U-shaped, ground
mounted/Stützklappgriff U-Förmig,
Bodenmontage/Откидной
U-образный поручень, с креплением
к полу

750 mm
813 mm
850 mm



**Sklopný úchyt ve tvaru U s opěrnou
nohou**

Folding grab bar U-shaped with
supporting leg/Stützklappgriff
U-Förmig mit Standfuss/Откидной
U-образный поручень с опорной
ножкой

600 mm 813 mm
750 mm 850 mm



**Sklopný úchyt ve tvaru U s opěrnou
nohou s držákem toaletního papíru**

Folding grab bar U-shaped
with supporting leg with toilet
paper holder/Stützklappgriff
in U-Förmig mit Standfuss mit
Toilettenpapierhalter/Откидной
U-образный поручень с опорной
ножкой и держателем туалетной
бумаги

600 mm 813 mm
750 mm 850 mm



Úhlové madlo 120°

Angled grab bar 120°/
Winkelgriff 120°/
Угловой поручень 120°
660×400 mm



Nástěnné opěrné držadlo*

Shower grab bar*/Haltegriff*/
Поручень для душа*

680 mm
890 mm



Madlo do sprchy se svislou opěrou*

Shower grab bar*/Duschgriff mit glatter senkrechter Stütze*/Поручень для душа*

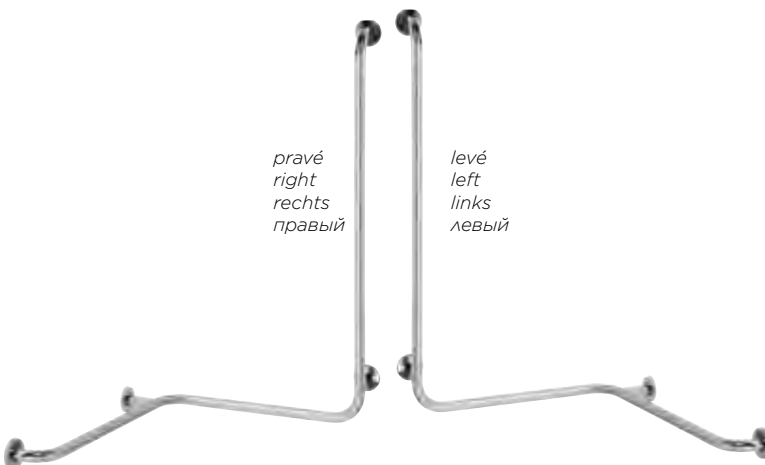

Opěrné madloGrab bar/Stützgriff/
Опорный поручень**Madlo do sprchy**Shower grab bar/Duschgriff/
Поручень для душа**Podpěrné madlo**Grab bar/Stützgriff/Опорный
поручень

500 mm

760 mm

**Sklopné sprchové sedátko**Reversible shower seat/
Duschklappsitz/
Откидное сиденье для душа**Sprchové sedátko**

Shower seat/Duschsitz/Сиденье для душа

**Kompletní nabídka programu HELP: katalog BEMETA HELP, www.bemeta.cz**The complete offer of the HELP program: catalogHELP, www.bemeta.comDas komplette Angebot des HELP-Programms: Katalog HELP, www.bemeta.comПолное предложение программы HELP: каталог HELP, www.bemeta.com

Design na zakázku

Custom design

Maßgefertigtes Design

Индивидуальный дизайн

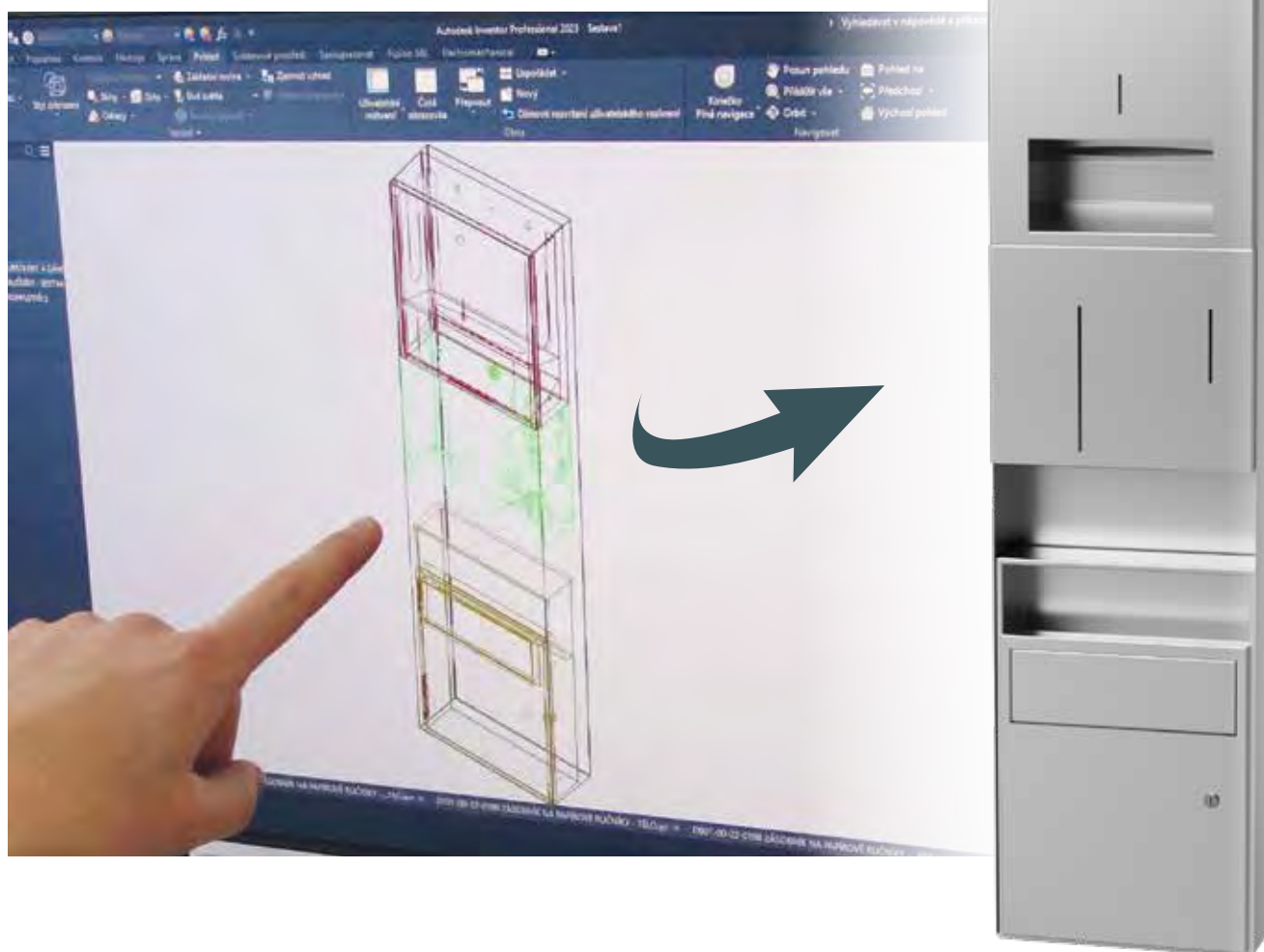

Přesné individuální přizpůsobení, speciální provedení.

I tyhle věci umíme! K doplnění našeho standardního sortimentu nabízíme speciální zákaznická řešení: přizpůsobení stávajících produktů i vytvoření zcela nových výrobků dle návrhu zákazníka a to vše během krátké doby. Toto vše může Bemeta nabídnout díky vlastní výrobě a týmu zkušených konstruktérů.

Accurate individual customized, special designs.

We can do ther things, too! To supplement our standard range, we offer special customer solutions: product adaptations as well as completely new designs from one source and within a short time, form sketch to finished product - thanks to in-house design and production in Reutlinge.

Präzise individuell angepasst, Sonderanfertigungen.

Das können wir auch! Ergänzend zu unserem Standardsortiment bieten wir spezielle Kundenlösungen: Produktanpassungen sowie komplette Neukonstruktionen aus einer Hand und innerhalb kurzer Zeit von der Formskizze zum fertigen Produkt - dank eigener Konstruktion und Fertigung in Reutlinge.

Индивидуальный подход и нестандартные решения.

Это тоже в наших силах! Дополнительно к стандартному ассортименту продукции мы предлагаем неординарные решения и создание совершенно новых продуктов по желанию заказчика. Все это - благодаря собственному производству и команде опытных дизайнеров.

Vestavné WC boxy

Bathroom built-in unit

Badezimmer Wandeinbaumodule

Встраиваемые модули для туалета



PLATE

Vestavný wc box z nerezové oceli na štětku a toaletní papír

Built-in Stainless steel container for toilet brush and toilet roll

WC Edelstahl Wandeinbaumodule mit Bürstengarnitur und Papierrollenhalter

Встраиваемый модуль для туалета



Typ oceli:
Steel grade:
Stahlsorte:
Тип стали:

- | | |
|-----------|---|
| SB | Kartáčovaná nerezová ocel Brushed stainless steel Gebürstet Edelstahl Шлифованная нержавеющая сталь 304/EN 1.4301 |
| WH | Bílá White Weiss Белая 304/EN 1.4301 |
| GR | Šedá metalíza Grey metallic Grau metallic Серый металл 304/EN 1.4301 |
| BL | Černá Black Schwarz Черная 304/EN 1.4301 |

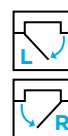

Levé (L)/pravé (R) otevírání na objednávku
Opening direction left (L)/right (R) to select
Türöffnung links (L)/rechts (R) zu Bestellen
Левое (L)/правое (R) открывание на заказ

**P.PW2D
WC 800**



SB

**P.PW2D LWH
WC 800**



WH

**P.PW2D LGR
WC 800**



GR

**P.PW2D LBL
WC 800**



BL

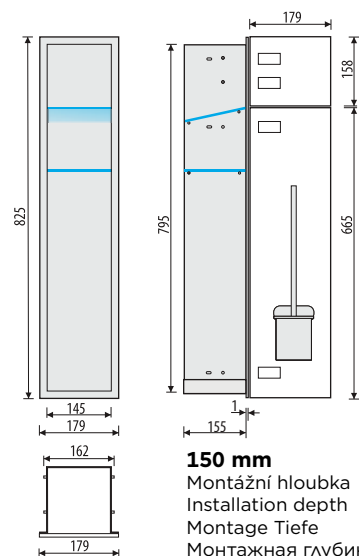

Verze Slim | Slim type | Slim version | Версия Slim

**P.PWAD
WC 450**



SB

**P.PWAD LWH
WC 450**



WH

**P.PWAD LGR
WC 450**



GR

**P.PWAD LBL
WC 450**



BL

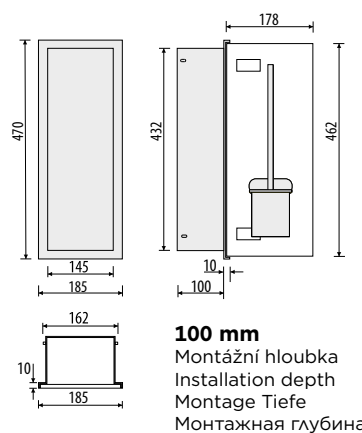



UNO

Vestavný wc box z nerezové oceli na štětku a toaletní papír s dvířky do obkladu

Built-in Stainless steel container for toilet with tileable doors

WC Edelstahl Wandeinbaumodule mit Bürstengarnitur und Papierrollenhalter mit befliesbaren Türen

Встраиваемый модуль для туалета с дверцей под плитку

Typ oceli:
Steel grade:
Stahlsorte:
Тип стали:

- SB** Kartáčovaná nerezová ocel | Brushed stainless steel | Gebürstet Edelstahl
Шлифованная нержавеющая сталь **304/EN 1.4301**
- WH** Bílá | White | Weiss | Белая **304/EN 1.4301**
- GR** Šedá metalíza | Grey metallic | Grau metallic
Серый металл **304/EN 1.4301**
- BL** Černá | Black | Schwarz | Черная **304/EN 1.4301**



Levé (L)/pravé (R) otevírání na objednávku
Opening direction left (L)/right (R) to select
Türöffnung links (L)/rechts (R) zu Bestellen
Левое (L)/правое (R) открывание на заказ

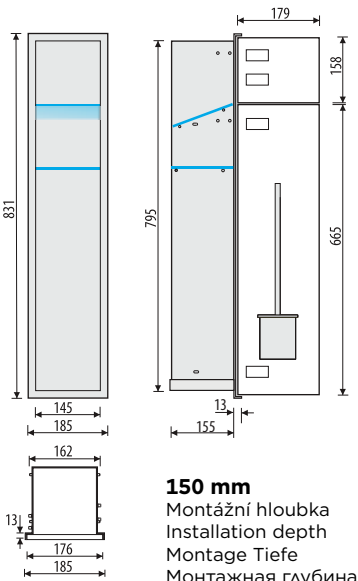

**U.PW2T
WC 800**



SB

**U.PW2T LWH
WC 800**



WH

**U.PW2T LGR
WC 800**



GR

**U.PW2T LBL
WC 800**



BL

Verze Slim | Slim type | Slim version | Версия Slim

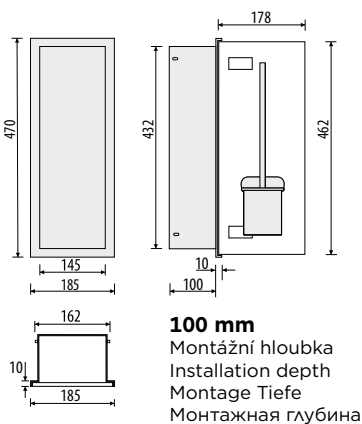

**U.PWAT
WC 450**



SB

**U.PWAT LWH
WC 450**



WH

**U.PWAT LGR
WC 450**



GR

**U.PWAT LBL
WC 450**



BL

Typy skla

Types of glass doors
Arten von Glastüren
Типы стекла

Mirror

MR

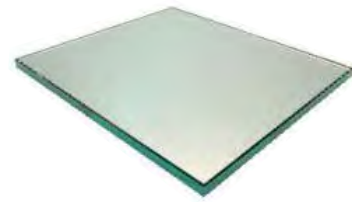

White glossy

WH

Grey glossy

GR

Black glossy

BL



White satin

ATWH

Latte satin

STLT

Black satin

STBL

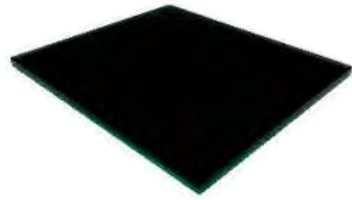
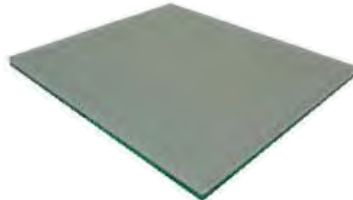

Montážní rám pro osazení boxu

Concealed mounting frame
Unterputz Einbaurahmen
Монтажная рама для установки встраиваемых модулей

BR 800 WC for/für/pro 800 PW2T/D

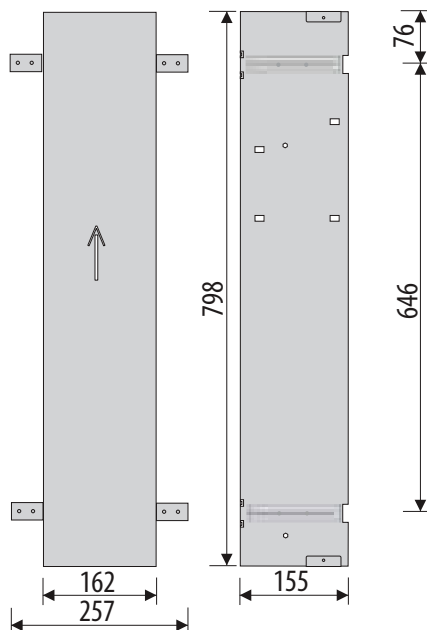

BR 450 WC for/für/pro 450 PWAD/T

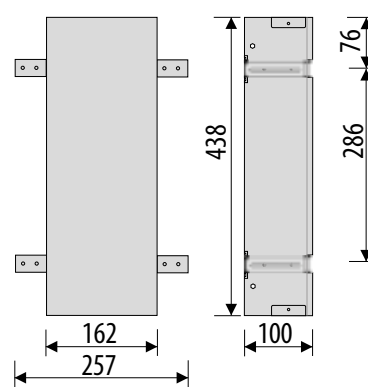

| Typ skříně Modul type Modultyp Тип шкафа | Výška Height Höhe Высота | Barva konstrukce Box colour Modulfarbe Цвет модуля | Pravé/Levé Right/Left Rechts/Links Право/Лево | Typ skla Glass door type Art von Glastüren Тип стекла | Описание Complete description Ganze Beschreibung Celý popis | Objednávkový kód Order no. Bestellnummer Код заказа |
|---|-----------------------------------|---|--|--|--|--|
| PLATE | | | | | | |
| P.PW2D | WC 800 | SB | (DIN R) | MR | P.PW2D SB WC 800 (DIN R) MR | 772201101 |
| P.PW2D | WC 800 | LWH | (DIN R) | MR | P.PW2D LWH WC 800 (DIN R) MR | 772202101 |
| P.PW2D | WC 800 | LGR | (DIN R) | MR | P.PW2D LGR WC 800 (DIN R) MR | 772203101 |
| P.PW2D | WC 800 | LBL | (DIN R) | MR | P.PW2D LBL WC 800 (DIN R) MR | 772204101 |
| P.PW2D | WC 800 | SB | (DIN R) | WH | P.PW2D SB WC 800 (DIN R) WH | 772201102 |
| P.PW2D | WC 800 | LWH | (DIN R) | WH | P.PW2D LWH WC 800 (DIN R) WH | 772202102 |
| P.PW2D | WC 800 | LGR | (DIN R) | WH | P.PW2D LGR WC 800 (DIN R) WH | 772203102 |
| P.PW2D | WC 800 | LBL | (DIN R) | WH | P.PW2D LBL WC 800 (DIN R) WH | 772204102 |
| P.PW2D | WC 800 | SB | (DIN R) | GR | P.PW2D SB WC 800 (DIN R) GR | 772201103 |
| P.PW2D | WC 800 | LWH | (DIN R) | GR | P.PW2D LWH WC 800 (DIN R) GR | 772202103 |
| P.PW2D | WC 800 | LGR | (DIN R) | GR | P.PW2D LGR WC 800 (DIN R) GR | 772203103 |
| P.PW2D | WC 800 | LBL | (DIN R) | GR | P.PW2D LBL WC 800 (DIN R) GR | 772204103 |
| P.PW2D | WC 800 | SB | (DIN R) | BL | P.PW2D SB WC 800 (DIN R) BL | 772201104 |
| P.PW2D | WC 800 | LWH | (DIN R) | BL | P.PW2D LWH WC 800 (DIN R) BL | 772202104 |
| P.PW2D | WC 800 | LGR | (DIN R) | BL | P.PW2D LGR WC 800 (DIN R) BL | 772203104 |
| P.PW2D | WC 800 | LBL | (DIN R) | BL | P.PW2D LBL WC 800 (DIN R) BL | 772204104 |
| P.PW2D | WC 800 | SB | (DIN R) | STWH | P.PW2D SB WC 800 (DIN R) STWH | 772201105 |
| P.PW2D | WC 800 | LWH | (DIN R) | STWH | P.PW2D LWH WC 800 (DIN R) STWH | 772202105 |
| P.PW2D | WC 800 | LGR | (DIN R) | STWH | P.PW2D LGR WC 800 (DIN R) STWH | 772203105 |
| P.PW2D | WC 800 | LBL | (DIN R) | STWH | P.PW2D LBL WC 800 (DIN R) STWH | 772204105 |
| P.PW2D | WC 800 | SB | (DIN R) | STLT | P.PW2D SB WC 800 (DIN R) STLT | 772201106 |
| P.PW2D | WC 800 | LWH | (DIN R) | STLT | P.PW2D LWH WC 800 (DIN R) STLT | 772202106 |
| P.PW2D | WC 800 | LGR | (DIN R) | STLT | P.PW2D LGR WC 800 (DIN R) STLT | 772203106 |
| P.PW2D | WC 800 | LBL | (DIN R) | STLT | P.PW2D LBL WC 800 (DIN R) STLT | 772204106 |
| P.PW2D | WC 800 | SB | (DIN R) | STBL | P.PW2D SB WC 800 (DIN R) STBL | 772201107 |
| P.PW2D | WC 800 | LWH | (DIN R) | STBL | P.PW2D LWH WC 800 (DIN R) STBL | 772202107 |
| P.PW2D | WC 800 | LGR | (DIN R) | STBL | P.PW2D LGR WC 800 (DIN R) STBL | 772203107 |
| P.PW2D | WC 800 | LBL | (DIN R) | STBL | P.PW2D LBL WC 800 (DIN R) STBL | 772204107 |
| P.PW2D | WC 800 | SB | (DIN L) | MR | P.PW2D SB WC 800 (DIN L) MR | 772201001 |
| P.PW2D | WC 800 | LWH | (DIN L) | MR | P.PW2D LWH WC 800 (DIN L) MR | 772202001 |
| P.PW2D | WC 800 | LGR | (DIN L) | MR | P.PW2D LGR WC 800 (DIN L) MR | 772203001 |
| P.PW2D | WC 800 | LBL | (DIN L) | MR | P.PW2D LBL WC 800 (DIN L) MR | 772204001 |
| P.PW2D | WC 800 | SB | (DIN L) | WH | P.PW2D SB WC 800 (DIN L) WH | 772201002 |
| P.PW2D | WC 800 | LWH | (DIN L) | WH | P.PW2D LWH WC 800 (DIN L) WH | 772202002 |
| P.PW2D | WC 800 | LGR | (DIN L) | WH | P.PW2D LGR WC 800 (DIN L) WH | 772203002 |
| P.PW2D | WC 800 | LBL | (DIN L) | WH | P.PW2D LBL WC 800 (DIN L) WH | 772204002 |
| P.PW2D | WC 800 | SB | (DIN L) | GR | P.PW2D SB WC 800 (DIN L) GR | 772201003 |
| P.PW2D | WC 800 | LWH | (DIN L) | GR | P.PW2D LWH WC 800 (DIN L) GR | 772202003 |
| P.PW2D | WC 800 | LGR | (DIN L) | GR | P.PW2D LGR WC 800 (DIN L) GR | 772203003 |
| P.PW2D | WC 800 | LBL | (DIN L) | GR | P.PW2D LBL WC 800 (DIN L) GR | 772204003 |
| P.PW2D | WC 800 | SB | (DIN L) | BL | P.PW2D SB WC 800 (DIN L) BL | 772201004 |
| P.PW2D | WC 800 | LWH | (DIN L) | BL | P.PW2D LWH WC 800 (DIN L) BL | 772202004 |
| P.PW2D | WC 800 | LGR | (DIN L) | BL | P.PW2D LGR WC 800 (DIN L) BL | 772203004 |
| P.PW2D | WC 800 | LBL | (DIN L) | BL | P.PW2D LBL WC 800 (DIN L) BL | 772204004 |
| P.PW2D | WC 800 | SB | (DIN L) | STWH | P.PW2D SB WC 800 (DIN L) STWH | 772201005 |
| P.PW2D | WC 800 | LWH | (DIN L) | STWH | P.PW2D LWH WC 800 (DIN L) STWH | 772202005 |
| P.PW2D | WC 800 | LGR | (DIN L) | STWH | P.PW2D LGR WC 800 (DIN L) STWH | 772203005 |
| P.PW2D | WC 800 | LBL | (DIN L) | STWH | P.PW2D LBL WC 800 (DIN L) STWH | 772204005 |
| P.PW2D | WC 800 | SB | (DIN L) | STLT | P.PW2D SB WC 800 (DIN L) STLT | 772201006 |
| P.PW2D | WC 800 | LWH | (DIN L) | STLT | P.PW2D LWH WC 800 (DIN L) STLT | 772202006 |
| P.PW2D | WC 800 | LGR | (DIN L) | STLT | P.PW2D LGR WC 800 (DIN L) STLT | 772203006 |
| P.PW2D | WC 800 | LBL | (DIN L) | STLT | P.PW2D LBL WC 800 (DIN L) STLT | 772204006 |
| P.PW2D | WC 800 | SB | (DIN L) | STBL | P.PW2D SB WC 800 (DIN L) STBL | 772201007 |
| P.PW2D | WC 800 | LWH | (DIN L) | STBL | P.PW2D LWH WC 800 (DIN L) STBL | 772202007 |

| Typ skříně Modul type Modultyp Тип шкафа | Výška Height Höhe Высота | Barva konstrukce Box colour Modulfarbe Цвет модуля | Pravé/Levé Right/Left Rechts/Links Право/Лево | Typ skla Glass door type Art von Glastüren Тип стекла | Описание Complete description Ganze Beschreibung Celý popis | Objednávkový kód Order no. Bestellnummer Код заказа |
|---|-----------------------------------|---|--|--|--|--|
| P.PW2D | WC 800 | LGR | (DIN L) | STBL | P.PW2D LGR WC 800 (DIN L) STBL | 772203007 |
| P.PW2D | WC 800 | LBL | (DIN L) | STBL | P.PW2D LBL WC 800 (DIN L) STBL | 772204007 |
| P.PWAD | WC 450 | SB | (DIN R) | MR | P.PWAD SBWC 450 (DIN R) MR | 774201101 |
| P.PWAD | WC 450 | LWH | (DIN R) | MR | P.PWAD LWHWC 450 (DIN R) MR | 774202101 |
| P.PWAD | WC 450 | LGR | (DIN R) | MR | P.PWAD LGRWC 450 (DIN R) MR | 774203101 |
| P.PWAD | WC 450 | LBL | (DIN R) | MR | P.PWAD LBLWC 450 (DIN R) MR | 774204101 |
| P.PWAD | WC 450 | SB | (DIN R) | WH | P.PWAD SBWC 450 (DIN R) WH | 774201102 |
| P.PWAD | WC 450 | LWH | (DIN R) | WH | P.PWAD LWHWC 450 (DIN R) WH | 774202102 |
| P.PWAD | WC 450 | LGR | (DIN R) | WH | P.PWAD LGRWC 450 (DIN R) WH | 774203102 |
| P.PWAD | WC 450 | LBL | (DIN R) | WH | P.PWAD LBLWC 450 (DIN R) WH | 774204102 |
| P.PWAD | WC 450 | SB | (DIN R) | GR | P.PWAD SBWC 450 (DIN R) GR | 774201103 |
| P.PWAD | WC 450 | LWH | (DIN R) | GR | P.PWAD LWHWC 450 (DIN R) GR | 774202103 |
| P.PWAD | WC 450 | LGR | (DIN R) | GR | P.PWAD LGRWC 450 (DIN R) GR | 774203103 |
| P.PWAD | WC 450 | LBL | (DIN R) | GR | P.PWAD LBLWC 450 (DIN R) GR | 774204103 |
| P.PWAD | WC 450 | SB | (DIN R) | BL | P.PWAD SBWC 450 (DIN R) BL | 774201104 |
| P.PWAD | WC 450 | LWH | (DIN R) | BL | P.PWAD LWHWC 450 (DIN R) BL | 774202104 |
| P.PWAD | WC 450 | LGR | (DIN R) | BL | P.PWAD LGRWC 450 (DIN R) BL | 774203104 |
| P.PWAD | WC 450 | LBL | (DIN R) | BL | P.PWAD LBLWC 450 (DIN R) BL | 774204104 |
| P.PWAD | WC 450 | SB | (DIN R) | STWH | P.PWAD SBWC 450 (DIN R) STWH | 774201105 |
| P.PWAD | WC 450 | LWH | (DIN R) | STWH | P.PWAD LWHWC 450 (DIN R) STWH | 774202105 |
| P.PWAD | WC 450 | LGR | (DIN R) | STWH | P.PWAD LGRWC 450 (DIN R) STWH | 774203105 |
| P.PWAD | WC 450 | LBL | (DIN R) | STWH | P.PWAD LBLWC 450 (DIN R) STWH | 774204105 |
| P.PWAD | WC 450 | SB | (DIN R) | STLT | P.PWAD SBWC 450 (DIN R) STLT | 774201106 |
| P.PWAD | WC 450 | LWH | (DIN R) | STLT | P.PWAD LWHWC 450 (DIN R) STLT | 774202106 |
| P.PWAD | WC 450 | LGR | (DIN R) | STLT | P.PWAD LGRWC 450 (DIN R) STLT | 774203106 |
| P.PWAD | WC 450 | LBL | (DIN R) | STLT | P.PWAD LBLWC 450 (DIN R) STLT | 774204106 |
| P.PWAD | WC 450 | SB | (DIN R) | STBL | P.PWAD SBWC 450 (DIN R) STBL | 774201107 |
| P.PWAD | WC 450 | LWH | (DIN R) | STBL | P.PWAD LWHWC 450 (DIN R) STBL | 774202107 |
| P.PWAD | WC 450 | LGR | (DIN R) | STBL | P.PWAD LGRWC 450 (DIN R) STBL | 774203107 |
| P.PWAD | WC 450 | LBL | (DIN R) | STBL | P.PWAD LBLWC 450 (DIN R) STBL | 774204107 |
| P.PWAD | WC 450 | SB | (DIN L) | MR | P.PWAD SBWC 450 (DIN L) MR | 774201001 |
| P.PWAD | WC 450 | LWH | (DIN L) | MR | P.PWAD LWHWC 450 (DIN L) MR | 774202001 |
| P.PWAD | WC 450 | LGR | (DIN L) | MR | P.PWAD LGRWC 450 (DIN L) MR | 774203001 |
| P.PWAD | WC 450 | LBL | (DIN L) | MR | P.PWAD LBLWC 450 (DIN L) MR | 774204001 |
| P.PWAD | WC 450 | SB | (DIN L) | WH | P.PWAD SBWC 450 (DIN L) WH | 774201002 |
| P.PWAD | WC 450 | LWH | (DIN L) | WH | P.PWAD LWHWC 450 (DIN L) WH | 774202002 |
| P.PWAD | WC 450 | LGR | (DIN L) | WH | P.PWAD LGRWC 450 (DIN L) WH | 774203002 |
| P.PWAD | WC 450 | LBL | (DIN L) | WH | P.PWAD LBLWC 450 (DIN L) WH | 774204002 |
| P.PWAD | WC 450 | SB | (DIN L) | GR | P.PWAD SBWC 450 (DIN L) GR | 774201003 |
| P.PWAD | WC 450 | LWH | (DIN L) | GR | P.PWAD LWHWC 450 (DIN L) GR | 774202003 |
| P.PWAD | WC 450 | LGR | (DIN L) | GR | P.PWAD LGRWC 450 (DIN L) GR | 774203003 |
| P.PWAD | WC 450 | LBL | (DIN L) | GR | P.PWAD LBLWC 450 (DIN L) GR | 774204003 |
| P.PWAD | WC 450 | SB | (DIN L) | BL | P.PWAD SBWC 450 (DIN L) BL | 774201004 |
| P.PWAD | WC 450 | LWH | (DIN L) | BL | P.PWAD LWHWC 450 (DIN L) BL | 774202004 |
| P.PWAD | WC 450 | LGR | (DIN L) | BL | P.PWAD LGRWC 450 (DIN L) BL | 774203004 |
| P.PWAD | WC 450 | LBL | (DIN L) | BL | P.PWAD LBLWC 450 (DIN L) BL | 774204004 |
| P.PWAD | WC 450 | SB | (DIN L) | STWH | P.PWAD SBWC 450 (DIN L) STWH | 774201005 |
| P.PWAD | WC 450 | LWH | (DIN L) | STWH | P.PWAD LWHWC 450 (DIN L) STWH | 774202005 |
| P.PWAD | WC 450 | LGR | (DIN L) | STWH | P.PWAD LGRWC 450 (DIN L) STWH | 774203005 |
| P.PWAD | WC 450 | LBL | (DIN L) | STWH | P.PWAD LBLWC 450 (DIN L) STWH | 774204005 |
| P.PWAD | WC 450 | SB | (DIN L) | STLT | P.PWAD SBWC 450 (DIN L) STLT | 774201006 |
| P.PWAD | WC 450 | LWH | (DIN L) | STLT | P.PWAD LWHWC 450 (DIN L) STLT | 774202006 |
| P.PWAD | WC 450 | LGR | (DIN L) | STLT | P.PWAD LGRWC 450 (DIN L) STLT | 774203006 |
| P.PWAD | WC 450 | LBL | (DIN L) | STLT | P.PWAD LBLWC 450 (DIN L) STLT | 774204006 |
| P.PWAD | WC 450 | SB | (DIN L) | STBL | P.PWAD SBWC 450 (DIN L) STBL | 774201007 |

| Typ skříně Modul type Modultyp Тип шкафа | Výška Height Höhe Высота | Barva konstrukce Box colour Modulfarbe Цвет модуля | Pravé/Levé Right/Left Rechts/Links Право/Лево | Typ skla Glass door type Art von Glastüren Тип стекла | Описание Complete description Ganze Beschreibung Celý popis | Objednávkový kód Order no. Bestellnummer Код заказа |
|---|-----------------------------------|---|--|--|--|--|
| P.PWAD | WC 450 | LWH | (DIN L) | STBL | P.PWAD LWHWC 450 (DIN L) STBL | 774202007 |
| P.PWAD | WC 450 | LGR | (DIN L) | STBL | P.PWAD LGRWC 450 (DIN L) STBL | 774203007 |
| P.PWAD | WC 450 | LBL | (DIN L) | STBL | P.PWAD LBLWC 450 (DIN L) STBL | 774204007 |
| UNO | | | | | | |
| U.PW2T | WC 800 | SB | (DIN R) | | U.PW2T SB WC 800 (DIN R) | 771201101 |
| U.PW2T | WC 800 | LWH | (DIN R) | | U.PW2T LWH WC 800 (DIN R) | 771202101 |
| U.PW2T | WC 800 | LGR | (DIN R) | | U.PW2T LGR WC 800 (DIN R) | 771203101 |
| U.PW2T | WC 800 | LBL | (DIN R) | | U.PW2T LBL WC 800 (DIN R) | 771204101 |
| U.PW2T | WC 800 | SB | (DIN L) | | U.PW2T SB WC 800 (DIN L) | 771201001 |
| U.PW2T | WC 800 | LWH | (DIN L) | | U.PW2T LWH WC 800 (DIN L) | 771202001 |
| U.PW2T | WC 800 | LGR | (DIN L) | | U.PW2T LGR WC 800 (DIN L) | 771203001 |
| U.PW2T | WC 800 | LBL | (DIN L) | | U.PW2T LBL WC 800 (DIN L) | 771204001 |
| U.PWAT | WC 450 | SB | (DIN R) | | U.PWAT SB WC 450 (DIN R) | 771301101 |
| U.PWAT | WC 450 | LWH | (DIN R) | | U.PWAT LWH WC 450 (DIN R) | 771302101 |
| U.PWAT | WC 450 | LGR | (DIN R) | | U.PWAT LGR WC 450 (DIN R) | 771303101 |
| U.PWAT | WC 450 | LBL | (DIN R) | | U.PWAT LBL WC 450 (DIN R) | 771304101 |
| U.PWAT | WC 450 | SB | (DIN L) | | U.PWAT SB WC 450 (DIN L) | 771301001 |
| U.PWAT | WC 450 | LWH | (DIN L) | | U.PWAT LWH WC 450 (DIN L) | 771302001 |
| U.PWAT | WC 450 | LGR | (DIN L) | | U.PWAT LGR WC 450 (DIN L) | 771303001 |
| U.PWAT | WC 450 | LBL | (DIN L) | | U.PWAT LBL WC 450 (DIN L) | 771304001 |
| BR 450 WC | | | | | | 779490101 |
| BR 800 WC | | | | | | 779290101 |



Poličky do koupelny z nerezové oceli

Bathroom shelves made of stainless steel

Badezimmerregale aus Edelstahl

Полочки для ванной из нержавеющей стали

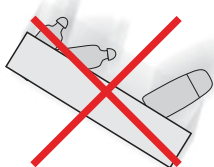

ANTI-DROP SYSTEM

Poličky do koupelny H-60mm

Bathroom shelves H-60mm

Badezimmerregale H-60mm

Полочки для ванной H-60mm



| | H ↓ | L ↔ | B ↗ |
|---------------|-----|-----|-----|
| BS6030 | 60 | 300 | 100 |
| BS6040 | 60 | 400 | 100 |
| BS6050 | 60 | 500 | 100 |
| BS6060 | 60 | 600 | 100 |



Volitelné barvy - práškové lakované
Possible colours of powder-coating
Mögliche Farben der Pulverbeschichtung
Дополнительные цвета - порошковое покрытие



Poličky do koupelny H-80mm

Bathroom shelves H-80mm

Badezimmerregale H-80mm

Полочки для ванной H-80mm



| | H ↓ | L ↔ | B ↗ |
|---------------|-----|-----|-----|
| BS8030 | 80 | 300 | 100 |
| BS8040 | 80 | 400 | 100 |
| BS8050 | 80 | 500 | 100 |
| BS8060 | 80 | 600 | 100 |

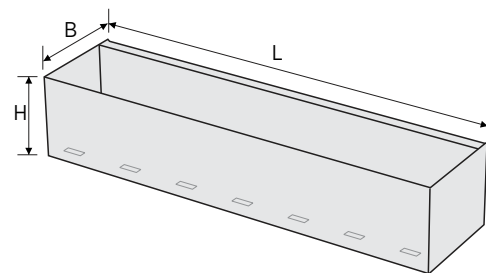

Volitelné barvy - práškové lakované
Possible colours of powder-coating
Mögliche Farben der Pulverbeschichtung
Дополнительные цвета - порошковое покрытие

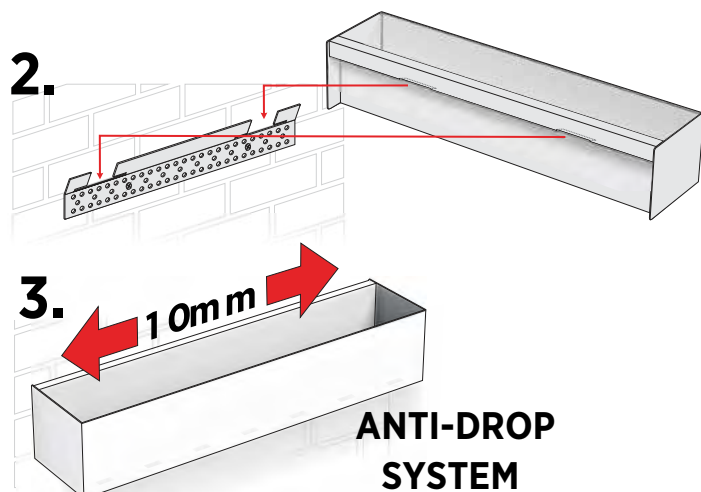
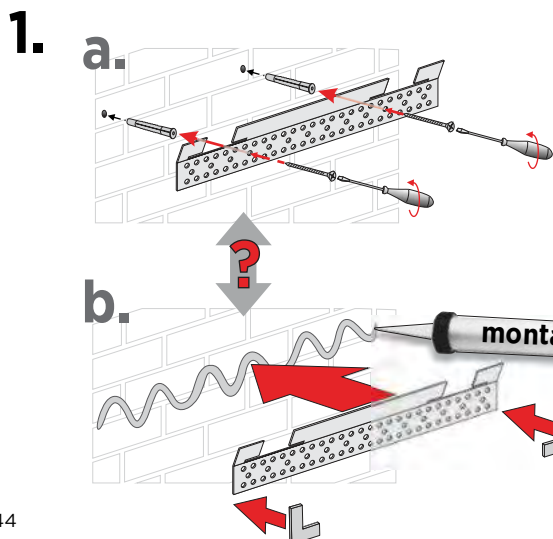

Vestavné police z nerezové oceli do niky

Built-in st. steel containers

Edelstahl Wandeinbaunische

Встраиваемые в нишу полки из нержавеющей стали



Typ oceli | Steel grade | Stahlsorte | Тип стали:

SB **Kartáčovaná nerezová ocel** | Brushed stainless steel |
Gebürstet Edelstahl | Шлифованная нержавеющая сталь **304/EN 1.4301**

WH **Bílá** | White | Weiss | Белая **304/EN 1.4301**

GR **Šedá metalíza** | Grey metallic |
Grau metallic | Серый металллик **304/EN 1.4301**

BL **Černá** | Black | Schwarz | Черная **304/EN 1.4301**

Vestavná polička z nerezů do niky

Built-in st. steel container
Edelstahl Wandeinbaunische
Встраиваемая в нишу полка из нержавеющей стали

P.PWN



SB

P.PWN LWH



WH

P.PWN LGR



GR

P.PWN LBL



BL

P.PWN 600/10
P.PWN 600/15*

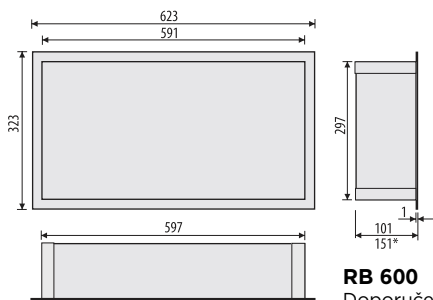

RB 600

Doporučený montážní rám
Suggested mounting frame
Empfohlener Einbaurahmen
Рекомендуемая монтажная рама

P.PWN 900/10
P.PWN 900/15*

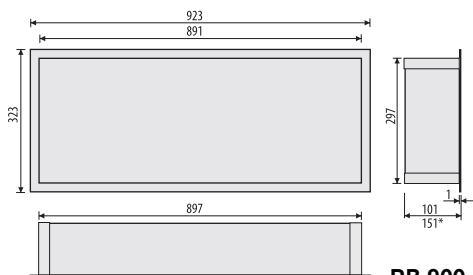

RB 900

Doporučený montážní rám
Suggested mounting frame
Empfohlener Einbaurahmen
Рекомендуемая монтажная рама



P.PWN 200/10
P.PWN 200/15*

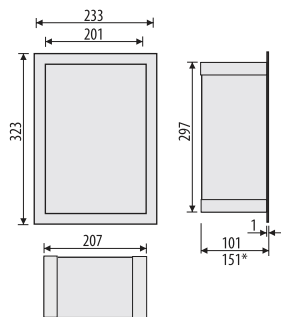

P.PWN 300/10
P.PWN 300/15*

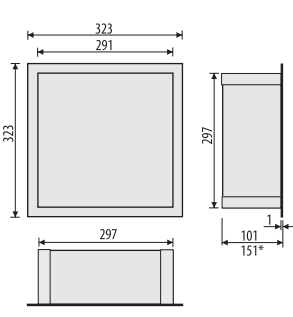

RB 200

Doporučený montážní rám
Suggested mounting frame
Empfohlener Einbaurahmen
Рекомендуемая монтажная рама

RB 300

Doporučený montážní rám
Suggested mounting frame
Empfohlener Einbaurahmen
Рекомендуемая монтажная рама

| Modul Module Modul Модуль | Hĺoubka cm Depth cm Tiefe cm Глубина см | Typ oceli Steel grade Stahlsorte Тип стали | Kód Code Code Код |
|------------------------------------|--|---|----------------------------|
| P.PWN 200 | 10 | SB | 781101001 |
| P.PWN 200 | 10 | LWH | 781101002 |
| P.PWN 200 | 10 | LBL | 781101003 |
| P.PWN 200 | 10 | LGR | 781101004 |
| P.PWN 300 | 10 | SB | 781101005 |
| P.PWN 300 | 10 | LWH | 781101006 |
| P.PWN 300 | 10 | LBL | 781101007 |
| P.PWN 300 | 10 | LGR | 781101008 |
| P.PWN 600 | 10 | SB | 781101009 |
| P.PWN 600 | 10 | LWH | 781101010 |
| P.PWN 600 | 10 | LBL | 781101011 |
| P.PWN 600 | 10 | LGR | 781101012 |
| P.PWN 900 | 10 | SB | 781101013 |
| P.PWN 900 | 10 | LWH | 781101014 |
| P.PWN 900 | 10 | LBL | 781101015 |
| P.PWN 900 | 10 | LGR | 781101016 |
| P.PWN 200 | 15 | SB | 781101017 |
| P.PWN 200 | 15 | LWH | 781101018 |
| P.PWN 200 | 15 | LBL | 781101019 |
| P.PWN 200 | 15 | LGR | 781101020 |
| P.PWN 300 | 15 | SB | 781101021 |
| P.PWN 300 | 15 | LWH | 781101022 |
| P.PWN 300 | 15 | LBL | 781101023 |
| P.PWN 300 | 15 | LGR | 781101024 |
| P.PWN 600 | 15 | SB | 781101025 |
| P.PWN 600 | 15 | LWH | 781101026 |
| P.PWN 600 | 15 | LBL | 781101027 |
| P.PWN 600 | 15 | LGR | 781101028 |
| P.PWN 900 | 15 | SB | 781101029 |
| P.PWN 900 | 15 | LWH | 781101030 |
| P.PWN 900 | 15 | LBL | 781101031 |
| P.PWN 900 | 15 | LGR | 781101032 |

Vestavná polička s LED osvětlením z nerezi do niky

Built-in st. steel container with LED lighting
Edelstahl Wandeinbaunisiche mit LED Beleuchtung
Встраиваемая в нишу полка из нерж. стали с подсветкой

X IP65 na objednávku
IP65 on request
IP65 nach Anfrage
IP65 на заказ

P.PWN LED



SB

P.PWH LWH LED



WH

P.PWN LGR LED



GR

P.PWN LBL LED



BL

P.PWN LED 200/10
P.PWN LED 200/15*

IP20 NW -4000K W ~1,92

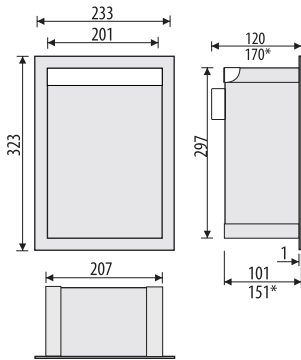

Pro | For | Für | Для
IP65 RBD 200/15 *17,5

RB 200
Doporučený montážní rám
Suggested mounting frame
Empfohlener Einbaurahmen
Рекомендуемая монтажная рама

P.PWN LED 300/10
P.PWN LED 300/15*

IP20 NW -4000K W ~2,64

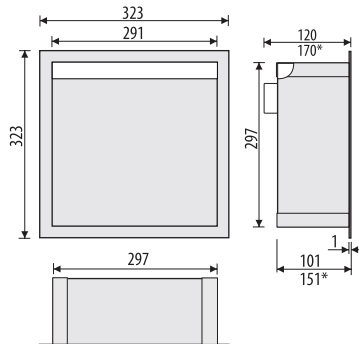

For | Für | Pro
IP65 RBD 300/15 *17,5

RB 300
Doporučený montážní rám
Suggested mounting frame
Empfohlener Einbaurahmen
Рекомендуемая монтажная рама

P.PWN LED 600/10
P.PWN LED 600/15*

IP20 NW -4000K W ~5,52

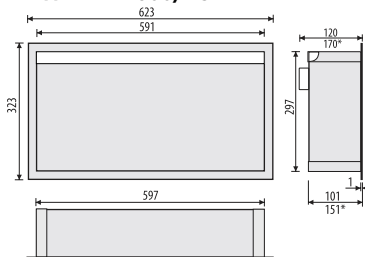

Pro | For | Für | Для
IP65 RBD 600/15 *17,5

RB 600
Doporučený montážní rám
Suggested mounting frame
Empfohlener Einbaurahmen
Рекомендуемая монтажная рама

P.PWN LED 900/10
P.PWN LED 900/15*

IP20 NW -4000K W ~8,4

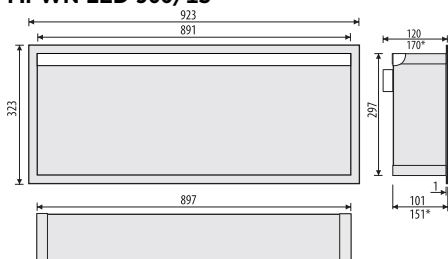

For | Für | Pro
IP65 RBD 900/15 *17,5

RB 900
Doporučený montážní rám
Suggested mounting frame
Empfohlener Einbaurahmen
Рекомендуемая монтажная рама

| Modul Module Modul Модуль | Hĺoubka cm Depth cm Tiefe cm Глубина см | Typ oceli Steel grade Stahlsorte Тип стали | Kód Code Code Код |
|------------------------------------|--|---|----------------------------|
| P.PWN 200 LED | 10 | SB | 781201001 |
| P.PWN 200 LED | 10 | LWH | 781201002 |
| P.PWN 200 LED | 10 | LBL | 781201003 |
| P.PWN 200 LED | 10 | LGR | 781201004 |
| P.PWN 300 LED | 10 | SB | 781201005 |
| P.PWN 300 LED | 10 | LWH | 781201006 |
| P.PWN 300 LED | 10 | LBL | 781201007 |
| P.PWN 300 LED | 10 | LGR | 781201008 |
| P.PWN 600 LED | 10 | SB | 781201009 |
| P.PWN 600 LED | 10 | LWH | 781201010 |
| P.PWN 600 LED | 10 | LBL | 781201011 |
| P.PWN 600 LED | 10 | LGR | 781201012 |
| P.PWN 900 LED | 10 | SB | 781201013 |
| P.PWN 900 LED | 10 | LWH | 781201014 |
| P.PWN 900 LED | 10 | LBL | 781201015 |
| P.PWN 900 LED | 10 | LGR | 781201016 |
| P.PWN 200 LED | 15 | SB | 781201017 |
| P.PWN 200 LED | 15 | LWH | 781201018 |
| P.PWN 200 LED | 15 | LBL | 781201019 |
| P.PWN 200 LED | 15 | LGR | 781201020 |
| P.PWN 300 LED | 15 | SB | 781201021 |
| P.PWN 300 LED | 15 | LWH | 781201022 |
| P.PWN 300 LED | 15 | LBL | 781201023 |
| P.PWN 300 LED | 15 | LGR | 781201024 |
| P.PWN 600 LED | 15 | SB | 781201025 |
| P.PWN 600 LED | 15 | LWH | 781201026 |
| P.PWN 600 LED | 15 | LBL | 781201027 |
| P.PWN 600 LED | 15 | LGR | 781201028 |
| P.PWN 900 LED | 15 | SB | 781201029 |
| P.PWN 900 LED | 15 | LWH | 781201030 |
| P.PWN 900 LED | 15 | LBL | 781201031 |
| P.PWN 900 LED | 15 | LGR | 781201032 |

Vestavná police z nerezí se skleněnými poličkami

Built-in st. steel container with glass shelves

Edelstahl Wandeinbaunische mit Glasablagen

Встраиваемая в нишу полка из нержавеющей стали со стеклянными полочками

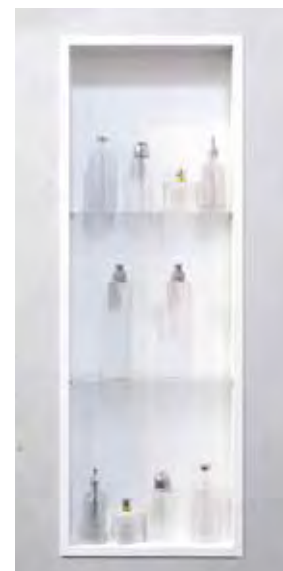

P.PWNP



SB

P.PWNP LWH



WH

P.PWNP LGR



GR

P.PWNP LGR



BL

**P.PWNP 3060/10
P.PWNP 3060/15***

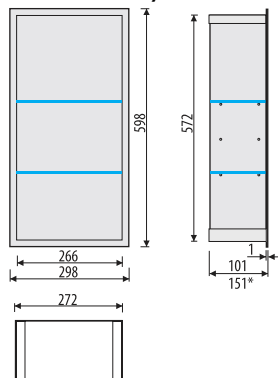

**P.PWNP 3080/10
P.PWNP 3080/15***

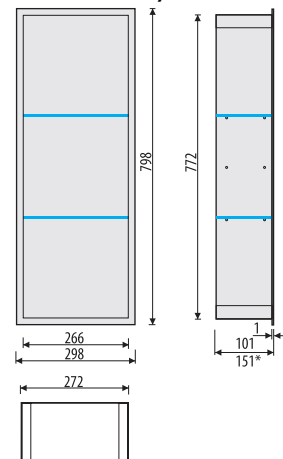

RB ES 3060

Doporučený montážní rám
Suggested mounting frame
Empfohlener Einbaurahmen
Рекомендуемая монтажная рама

RB ES 3080

Doporučený montážní rám
Suggested mounting frame
Empfohlener Einbaurahmen
Рекомендуемая монтажная рама

**P.PWNP 600/10
P.PWNP 600/15***

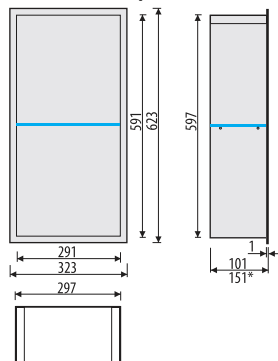

**P.PWNP 900/10
P.PWNP 900/15***

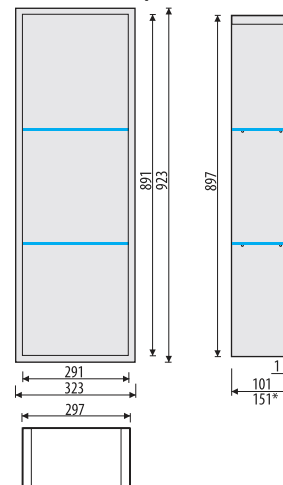

RB 600

Doporučený montážní rám
Suggested mounting frame
Empfohlener Einbaurahmen
Рекомендуемая монтажная рама

RB 900

Doporučený montážní rám
Suggested mounting frame
Empfohlener Einbaurahmen
Рекомендуемая монтажная рама

| Modul Module Modul Модуль | Hĺoubka cm Depth cm Tiefe cm Глубина см | Typ oceli Steel grade Stahlsorte Тип стали | Kód Code Code Код |
|------------------------------------|--|---|----------------------------|
| P.PWNP 3060 | 10 | SB | 781301001 |
| P.PWNP 3060 | 10 | LWH | 781301002 |
| P.PWNP 3060 | 10 | LBL | 781301003 |
| P.PWNP 3060 | 10 | LGR | 781301004 |
| P.PWNP 3080 | 10 | SB | 781301005 |
| P.PWNP 3080 | 10 | LWH | 781301006 |
| P.PWNP 3080 | 10 | LBL | 781301007 |
| P.PWNP 3080 | 10 | LGR | 781301008 |
| P.PWNP 600 | 10 | SB | 781301009 |
| P.PWNP 600 | 10 | LWH | 781301010 |
| P.PWNP 600 | 10 | LBL | 781301011 |
| P.PWNP 600 | 10 | LGR | 781301012 |
| P.PWNP 900 | 10 | SB | 781301013 |
| P.PWNP 900 | 10 | LWH | 781301014 |
| P.PWNP 900 | 10 | LBL | 781301015 |
| P.PWNP 900 | 10 | LGR | 781301016 |

Vestavná police z nerezí s LED osvětlením se skleněnými poličkami

Built-in st. steel container with LED lightinh and glass shelves

Edelstahl Wandeinbaunische mit LED Beleuchtung und Glasablagen

Встраиваемая в нишу полка из нержавеющей стали со стеклянными полочками и светодиодной подсветкой

P.PWNP LED



SB

P.PWNP LWH LED



WH

P.PWNP LGR LED



GR

P.PWNP LBL LED



BL

P.PWNP LED 3060/10
P.PWNP LED 3060/15*

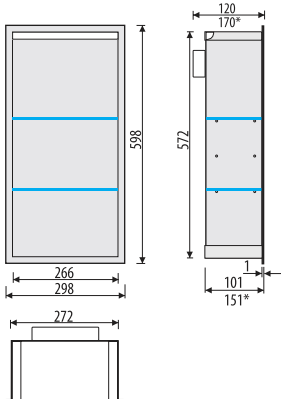

P.PWNP LED 600/10
P.PWNP LED 600/15*

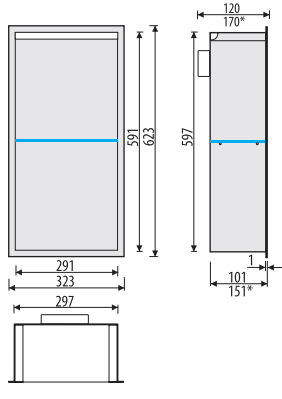

P.PWNP LED 3080/10
P.PWNP LED 3080/15*

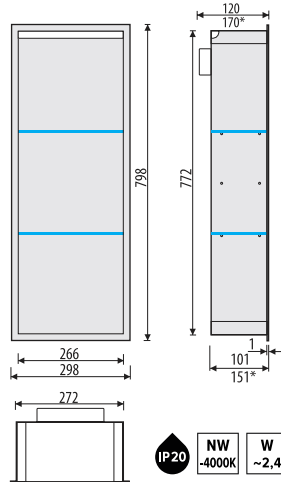

P.PWNP LED 900/10
P.PWNP LED 900/15*

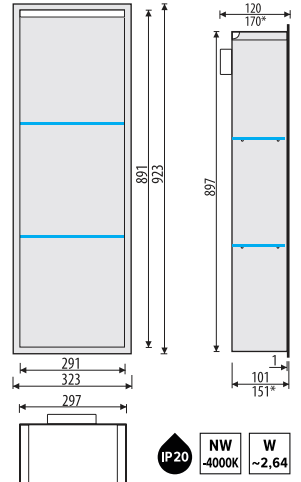

RB ES 3060

Doporučený montážní rám
Suggested mounting frame
Empfohlener Einbaurahmen
Рекомендуемая монтажная рама

RB 600

Doporučený montážní rám
Suggested mounting frame
Empfohlener Einbaurahmen
Рекомендуемая монтажная рама

RB ES 3080

Doporučený montážní rám
Suggested mounting frame
Empfohlener Einbaurahmen
Рекомендуемая монтажная рама

RB 900

Doporučený montážní rám
Suggested mounting frame
Empfohlener Einbaurahmen
Рекомендуемая монтажная рама

| Modul Module Modul Модуль | Hĺoubka cm Depth cm Tiefe cm Глубина см | Typ oceli Steel grade Stahlsorte Тип стали | Kód Code Code Код | Modul Module Modul Модуль | Hĺoubka cm Depth cm Tiefe cm Глубина см | Typ oceli Steel grade Stahlsorte Тип стали | Kód Code Code Код | Modul Module Modul Модуль | Hĺoubka cm Depth cm Tiefe cm Глубина см | Typ oceli Steel grade Stahlsorte Тип стали | Kód Code Code Код |
|------------------------------------|--|---|----------------------------|------------------------------------|--|---|----------------------------|------------------------------------|--|---|----------------------------|
| P.PWNP 3060 | 15 | SB | 781301017 | P.PWNP 3080 | 15 | LBL | 781301023 | P.PWNP 900 | 15 | SB | 781301029 |
| P.PWNP 3060 | 15 | LWH | 781301018 | P.PWNP 3080 | 15 | LGR | 781301024 | P.PWNP 900 | 15 | LWH | 781301030 |
| P.PWNP 3060 | 15 | LBL | 781301019 | P.PWNP 600 | 15 | SB | 781301025 | P.PWNP 900 | 15 | LBL | 781301031 |
| P.PWNP 3060 | 15 | LGR | 781301020 | P.PWNP 600 | 15 | LWH | 781301026 | P.PWNP 900 | 15 | LGR | 781301032 |
| P.PWNP 3080 | 15 | SB | 781301021 | P.PWNP 600 | 15 | LBL | 781301027 | | | | |
| P.PWNP 3080 | 15 | LWH | 781301022 | P.PWNP 600 | 15 | LGR | 781301028 | | | | |

Vestavné police z nerezí se skleněnými poličkami a dvířky

Built-in st. steel container with glass shelves and doors
 Edelstahl Wandeinbaunische mit Glasablagen und Glastür
 Встраиваемая в нишу полка из нержавеющей стали со стеклянными полочками и дверцей

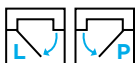

Levé/pravé otevírání na objednávku | Opening direction to select |
 Türöffnung zu Bestellen | Открывание влево/вправо по заказу

P.PWD



SB

P.PWD LWH



WH

P.PWD LGR



GR

P.PWD LBL



BL

P.PWD 3060/10
P.PWD 3060/15*

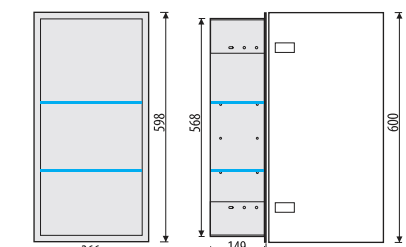

RB ES 3060

Doporučený montážní rám
 Suggested mounting frame
 Empfohlener Einbaurahmen
 Рекомендуемая монтажная рама

P.PWD 3080/10
P.PWD 3080/15*

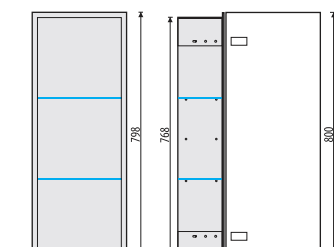

RB ES 3080

Doporučený montážní rám
 Suggested mounting frame
 Empfohlener Einbaurahmen
 Рекомендуемая монтажная рама

P.PWD 300/10
P.PWD 300/15*

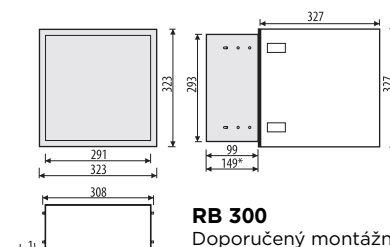

RB 300

Doporučený montážní rám
 Suggested mounting frame
 Empfohlener Einbaurahmen
 Рекомендуемая монтажная рама

P.PWD 600/10
P.PWD 600/15*

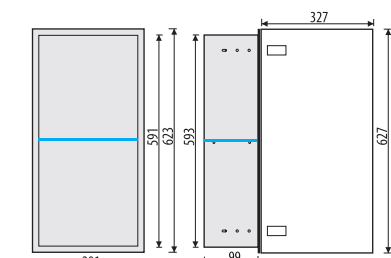

RB 600

Doporučený montážní rám
 Suggested mounting frame
 Empfohlener Einbaurahmen
 Рекомендуемая монтажная рама

P.PWD 900/10
P.PWD 900/15*

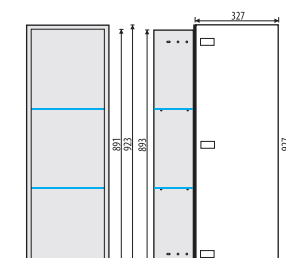

RB 900

Doporučený montážní rám
 Suggested mounting frame
 Empfohlener Einbaurahmen
 Рекомендуемая монтажная рама

P.PWD 3060/10 cm

| Typ oceli Steel grade Stahlsorte Тип стали | Otevírání Opening Türöffnung Открывание | Sklo Glass Glas Стекло | Kód Code Code Код |
|---|--|---------------------------------|----------------------------|
| SB | DIN L | MR | 781501001 |
| SB | DIN L | WH | 781501002 |
| SB | DIN L | BL | 781501003 |
| SB | DIN L | GR | 781501004 |
| SB | DIN L | STWH | 781501005 |
| SB | DIN L | STBL | 781501006 |
| SB | DIN L | STLT | 781501007 |
| SB | DIN R | MR | 781501008 |
| SB | DIN R | WH | 781501009 |
| SB | DIN R | BL | 781501010 |
| SB | DIN R | GR | 781501011 |
| SB | DIN R | STWH | 781501012 |
| SB | DIN R | STBL | 781501013 |
| SB | DIN R | STLT | 781501014 |
| WH | DIN L | MR | 781501015 |
| WH | DIN L | WH | 781501016 |
| WH | DIN L | BL | 781501017 |
| WH | DIN L | GR | 781501018 |
| WH | DIN L | STWH | 781501019 |
| WH | DIN L | STBL | 781501020 |
| WH | DIN L | STLT | 781501021 |
| WH | DIN R | MR | 781501022 |
| WH | DIN R | WH | 781501023 |
| WH | DIN R | BL | 781501024 |
| WH | DIN R | GR | 781501025 |
| WH | DIN R | STWH | 781501026 |
| WH | DIN R | STBL | 781501027 |
| WH | DIN R | STLT | 781501028 |
| BL | DIN L | MR | 781501029 |
| BL | DIN L | WH | 781501030 |
| BL | DIN L | BL | 781501031 |
| BL | DIN L | GR | 781501032 |
| BL | DIN L | STWH | 781501033 |
| BL | DIN L | STBL | 781501034 |
| BL | DIN L | STLT | 781501035 |
| BL | DIN R | MR | 781501036 |
| BL | DIN R | WH | 781501037 |
| BL | DIN R | BL | 781501038 |
| BL | DIN R | GR | 781501039 |
| BL | DIN R | STWH | 781501040 |
| BL | DIN R | STBL | 781501041 |
| BL | DIN R | STLT | 781501042 |
| GR | DIN L | MR | 781501043 |
| GR | DIN L | WH | 781501044 |
| GR | DIN L | BL | 781501045 |
| GR | DIN L | GR | 781501046 |
| GR | DIN L | STWH | 781501047 |
| GR | DIN L | STBL | 781501048 |
| GR | DIN L | STLT | 781501049 |
| GR | DIN R | MR | 781501050 |
| GR | DIN R | WH | 781501051 |
| GR | DIN R | BL | 781501052 |
| GR | DIN R | GR | 781501053 |
| GR | DIN R | STWH | 781501054 |
| GR | DIN R | STBL | 781501055 |
| GR | DIN R | STLT | 781501056 |

P.PWD 3060/15 cm

| Typ oceli Steel grade Stahlsorte Тип стали | Otevírání Opening Türöffnung Открывание | Sklo Glass Glas Стекло | Kód Code Code Код |
|---|--|---------------------------------|----------------------------|
| SB | DIN L | MR | 781502001 |
| SB | DIN L | WH | 781502002 |
| SB | DIN L | BL | 781502003 |
| SB | DIN L | GR | 781502004 |
| SB | DIN L | STWH | 781502005 |
| SB | DIN L | STBL | 781502006 |
| SB | DIN L | STLT | 781502007 |
| SB | DIN R | MR | 781502008 |
| SB | DIN R | WH | 781502009 |

P.PWD 3060/15 cm

| Typ oceli Steel grade Stahlsorte Тип стали | Otevírání Opening Türöffnung Открывание | Sklo Glass Glas Стекло | Kód Code Code Код |
|---|--|---------------------------------|----------------------------|
| SB | DIN R | BL | 781502010 |
| SB | DIN R | GR | 781502011 |
| SB | DIN R | STWH | 781502012 |
| SB | DIN R | STBL | 781502013 |
| SB | DIN R | STLT | 781502014 |
| WH | DIN L | MR | 781502015 |
| WH | DIN L | WH | 781502016 |
| WH | DIN L | BL | 781502017 |
| WH | DIN L | GR | 781502018 |
| WH | DIN L | STWH | 781502019 |
| WH | DIN L | STBL | 781502020 |
| WH | DIN L | STLT | 781502021 |
| WH | DIN R | MR | 781502022 |
| WH | DIN R | WH | 781502023 |
| WH | DIN R | BL | 781502024 |
| WH | DIN R | GR | 781502025 |
| WH | DIN R | STWH | 781502026 |
| WH | DIN R | STBL | 781502027 |
| WH | DIN R | STLT | 781502028 |
| BL | DIN L | MR | 781502029 |
| BL | DIN L | WH | 781502030 |
| BL | DIN L | BL | 781502031 |
| BL | DIN L | GR | 781502032 |
| BL | DIN L | STWH | 781502033 |
| BL | DIN L | STBL | 781502034 |
| BL | DIN L | STLT | 781502035 |
| BL | DIN R | MR | 781502036 |
| BL | DIN R | WH | 781502037 |
| BL | DIN R | BL | 781502038 |
| BL | DIN R | GR | 781502039 |
| BL | DIN R | STWH | 781502040 |
| BL | DIN R | STBL | 781502041 |
| BL | DIN R | STLT | 781502042 |
| GR | DIN L | MR | 781502043 |
| GR | DIN L | WH | 781502044 |
| GR | DIN L | BL | 781502045 |
| GR | DIN L | GR | 781502046 |
| GR | DIN L | STWH | 781502047 |
| GR | DIN L | STBL | 781502048 |
| GR | DIN L | STLT | 781502049 |
| GR | DIN R | MR | 781502050 |
| GR | DIN R | WH | 781502051 |
| GR | DIN R | BL | 781502052 |
| GR | DIN R | GR | 781502053 |
| GR | DIN R | STWH | 781502054 |
| GR | DIN R | STBL | 781502055 |
| GR | DIN R | STLT | 781502056 |

P.PWD 3080/10 cm

| Typ oceli Steel grade Stahlsorte Тип стали | Otevírání Opening Türöffnung Открывание | Sklo Glass Glas Стекло | Kód Code Code Код |
|---|--|---------------------------------|----------------------------|
| SB | DIN L | MR | 781601001 |
| SB | DIN L | WH | 781601002 |
| SB | DIN L | BL | 781601003 |
| SB | DIN L | GR | 781601004 |
| SB | DIN L | STWH | 781601005 |
| SB | DIN L | STBL | 781601006 |
| SB | DIN L | STLT | 781601007 |
| SB | DIN R | MR | 781601008 |
| SB | DIN R | WH | 781601009 |
| SB | DIN R | BL | 781601010 |
| SB | DIN R | GR | 781601011 |
| SB | DIN R | STWH | 781601012 |
| SB | DIN R | STBL | 781601013 |
| SB | DIN R | STLT | 781601014 |
| WH | DIN L | MR | 781601015 |
| WH | DIN L | WH | 781601016 |
| WH | DIN L | BL | 781601017 |
| WH | DIN L | GR | 781601018 |
| WH | DIN L | STWH | 781601019 |

P.PWD 3080/10 cm

| Typ oceli Steel grade Stahlsorte Тип стали | Otevírání Opening Türöffnung Открывание | Sklo Glass Glas Стекло | Kód Code Code Код |
|---|--|---------------------------------|----------------------------|
| WH | DIN L | STBL | 781601020 |
| WH | DIN L | STLT | 781601021 |
| WH | DIN R | MR | 781601022 |
| WH | DIN R | WH | 781601023 |
| WH | DIN R | BL | 781601024 |
| WH | DIN R | GR | 781601025 |
| WH | DIN R | STWH | 781601026 |
| WH | DIN R | STBL | 781601027 |
| WH | DIN R | STLT | 781601028 |
| BL | DIN L | MR | 781601029 |
| BL | DIN L | WH | 781601030 |
| BL | DIN L | BL | 781601031 |
| BL | DIN L | GR | 781601032 |
| BL | DIN L | STWH | 781601033 |
| BL | DIN L | STBL | 781601034 |
| BL | DIN L | STLT | 781601035 |
| BL | DIN R | MR | 781601036 |
| BL | DIN R | WH | 781601037 |
| BL | DIN R | BL | 781601038 |
| BL | DIN R | GR | 781601039 |
| BL | DIN R | STWH | 781601040 |
| BL | DIN R | STBL | 781601041 |
| BL | DIN R | STLT | 781601042 |
| GR | DIN L | MR | 781601043 |
| GR | DIN L | WH | 781601044 |
| GR | DIN L | BL | 781601045 |
| GR | DIN L | GR | 781601046 |
| GR | DIN L | STWH | 781601047 |
| GR | DIN L | STBL | 781601048 |
| GR | DIN L | STLT | 781601049 |
| GR | DIN R | MR | 781601050 |
| GR | DIN R | WH | 781601051 |
| GR | DIN R | BL | 781601052 |
| GR | DIN R | GR | 781601053 |
| GR | DIN R | STWH | 781601054 |
| GR | DIN R | STBL | 781601055 |
| GR | DIN R | STLT | 781601056 |

P.PWD 3060/10 cm

| Typ oceli Steel grade Stahlsorte Тип стали | Otevírání Opening Türöffnung Открывание | Sklo Glass Glas Стекло | Kód Code Code Код |
|---|--|---------------------------------|----------------------------|
| SB | DIN L | MR | 781602001 |
| SB | DIN L | WH | 781602002 |
| SB | DIN L | BL | 781602003 |
| SB | DIN L | GR | 781602004 |
| SB | DIN L | STWH | 781602005 |
| SB | DIN L | STBL | 781602006 |
| SB | DIN L | STLT | 781602007 |
| SB | DIN R | MR | 781602008 |
| SB | DIN R | WH | 781602009 |
| SB | DIN R | BL | 781602010 |
| SB | DIN R | GR | 781602011 |
| SB | DIN R | STWH | 781602012 |
| SB | DIN R | STBL | 781602013 |
| SB | DIN R | STLT | 781602014 |
| WH | DIN L | MR | 781602015 |
| WH | DIN L | WH | 781602016 |
| WH | DIN L | BL | 781602017 |
| WH | DIN L | GR | 781602018 |
| WH | DIN L | STWH | 781602019 |
| WH | DIN L | STBL | 781602020 |
| WH | DIN L | STLT | 781602021 |
| WH | DIN R | MR | 781602022 |
| WH | DIN R | WH | 781602023 |
| WH | DIN R | BL | 781602024 |
| WH | DIN R | GR | 781602025 |
| WH | DIN R | STWH | 781602026 |
| WH | DIN R | STBL | 781602027 |
| WH | DIN R | STLT | 781602028 |
| BL | DIN L | MR | 781602029 |
| BL | DIN L | WH | 781602030 |

P.PWD 3060/10 cm

| Typ oceli Steel grade Stahlsorte Тип стали | Otevirání Opening Türöffnung Открытие | Sklo Glass Glas Стекло | Kód Code Code Код |
|---|--|---------------------------------|----------------------------|
| BL | DIN L | BL | 781602031 |
| BL | DIN L | GR | 781602032 |
| BL | DIN L | STWH | 781602033 |
| BL | DIN L | STBL | 781602034 |
| BL | DIN L | STLT | 781602035 |
| BL | DIN R | MR | 781602036 |
| BL | DIN R | WH | 781602037 |
| BL | DIN R | BL | 781602038 |
| BL | DIN R | GR | 781602039 |
| BL | DIN R | STWH | 781602040 |
| BL | DIN R | STBL | 781602041 |
| BL | DIN R | STLT | 781602042 |
| GR | DIN L | MR | 781602043 |
| GR | DIN L | WH | 781602044 |
| GR | DIN L | BL | 781602045 |
| GR | DIN L | GR | 781602046 |
| GR | DIN L | STWH | 781602047 |
| GR | DIN L | STBL | 781602048 |
| GR | DIN L | STLT | 781602049 |
| GR | DIN R | MR | 781602050 |
| GR | DIN R | WH | 781602051 |
| GR | DIN R | BL | 781602052 |
| GR | DIN R | GR | 781602053 |
| GR | DIN R | STWH | 781602054 |
| GR | DIN R | STBL | 781602055 |
| GR | DIN R | STLT | 781602056 |

P.PWD 300/10 cm

| Typ oceli Steel grade Stahlsorte Тип стали | Otevirání Opening Türöffnung Открытие | Sklo Glass Glas Стекло | Kód Code Code Код |
|---|--|---------------------------------|----------------------------|
| SB | DIN L | MR | 781701001 |
| SB | DIN L | WH | 781701002 |
| SB | DIN L | BL | 781701003 |
| SB | DIN L | GR | 781701004 |
| SB | DIN L | STWH | 781701005 |
| SB | DIN L | STBL | 781701006 |
| SB | DIN L | STLT | 781701007 |
| SB | DIN R | MR | 781701008 |
| SB | DIN R | WH | 781701009 |
| SB | DIN R | BL | 781701010 |
| SB | DIN R | GR | 781701011 |
| SB | DIN R | STWH | 781701012 |
| SB | DIN R | STBL | 781701013 |
| SB | DIN R | STLT | 781701014 |
| WH | DIN L | MR | 781701015 |
| WH | DIN L | WH | 781701016 |
| WH | DIN L | BL | 781701017 |
| WH | DIN L | GR | 781701018 |
| WH | DIN L | STWH | 781701019 |
| WH | DIN L | STBL | 781701020 |
| WH | DIN L | STLT | 781701021 |
| WH | DIN R | MR | 781701022 |
| WH | DIN R | WH | 781701023 |
| WH | DIN R | BL | 781701024 |
| WH | DIN R | GR | 781701025 |
| WH | DIN R | STWH | 781701026 |
| WH | DIN R | STBL | 781701027 |
| WH | DIN R | STLT | 781701028 |
| BL | DIN L | MR | 781701029 |
| BL | DIN L | WH | 781701030 |
| BL | DIN L | BL | 781701031 |
| BL | DIN L | GR | 781701032 |
| BL | DIN L | STWH | 781701033 |
| BL | DIN L | STBL | 781701034 |
| BL | DIN L | STLT | 781701035 |
| BL | DIN R | MR | 781701036 |
| BL | DIN R | WH | 781701037 |
| BL | DIN R | BL | 781701038 |
| BL | DIN R | GR | 781701039 |

P.PWD 300/10 cm

| Typ oceli Steel grade Stahlsorte Тип стали | Otevirání Opening Türöffnung Открытие | Sklo Glass Glas Стекло | Kód Code Code Код |
|---|--|---------------------------------|----------------------------|
| BL | DIN R | STWH | 781701040 |
| BL | DIN R | STBL | 781701041 |
| BL | DIN R | STLT | 781701042 |
| GR | DIN L | MR | 781701043 |
| GR | DIN L | WH | 781701044 |
| GR | DIN L | BL | 781701045 |
| GR | DIN L | GR | 781701046 |
| GR | DIN L | STWH | 781701047 |
| GR | DIN L | STBL | 781701048 |
| GR | DIN L | STLT | 781701049 |
| GR | DIN R | MR | 781701050 |
| GR | DIN R | WH | 781701051 |
| GR | DIN R | BL | 781701052 |
| GR | DIN R | GR | 781701053 |
| GR | DIN R | STWH | 781701054 |
| GR | DIN R | STBL | 781701055 |
| GR | DIN R | STLT | 781701056 |

P.PWD 300/15 cm

| Typ oceli Steel grade Stahlsorte Тип стали | Otevirání Opening Türöffnung Открытие | Sklo Glass Glas Стекло | Kód Code Code Код |
|---|--|---------------------------------|----------------------------|
| SB | DIN L | MR | 781702001 |
| SB | DIN L | WH | 781702002 |
| SB | DIN L | BL | 781702003 |
| SB | DIN L | GR | 781702004 |
| SB | DIN L | STWH | 781702005 |
| SB | DIN L | STBL | 781702006 |
| SB | DIN L | STLT | 781702007 |
| SB | DIN R | MR | 781702008 |
| SB | DIN R | WH | 781702009 |
| SB | DIN R | BL | 781702010 |
| SB | DIN R | GR | 781702011 |
| SB | DIN R | STWH | 781702012 |
| SB | DIN R | STBL | 781702013 |
| SB | DIN R | STLT | 781702014 |
| WH | DIN L | MR | 781702015 |
| WH | DIN L | WH | 781702016 |
| WH | DIN L | BL | 781702017 |
| WH | DIN L | GR | 781702018 |
| WH | DIN L | STWH | 781702019 |
| WH | DIN L | STBL | 781702020 |
| WH | DIN L | STLT | 781702021 |
| WH | DIN R | MR | 781702022 |
| WH | DIN R | WH | 781702023 |
| WH | DIN R | BL | 781702024 |
| WH | DIN R | GR | 781702025 |
| WH | DIN R | STWH | 781702026 |
| WH | DIN R | STBL | 781702027 |
| WH | DIN R | STLT | 781702028 |
| BL | DIN L | MR | 781702029 |
| BL | DIN L | WH | 781702030 |
| BL | DIN L | BL | 781702031 |
| BL | DIN L | GR | 781702032 |
| BL | DIN L | STWH | 781702033 |
| BL | DIN L | STBL | 781702034 |
| BL | DIN L | STLT | 781702035 |
| BL | DIN R | MR | 781702036 |
| BL | DIN R | WH | 781702037 |
| BL | DIN R | BL | 781702038 |
| BL | DIN R | GR | 781702039 |
| BL | DIN R | STWH | 781702040 |
| BL | DIN R | STBL | 781702041 |
| BL | DIN R | STLT | 781702042 |
| GR | DIN L | MR | 781702043 |
| GR | DIN L | WH | 781702044 |
| GR | DIN L | BL | 781702045 |
| GR | DIN L | GR | 781702046 |
| GR | DIN L | STWH | 781702047 |
| GR | DIN L | STBL | 781702048 |
| GR | DIN L | STLT | 781702049 |
| GR | DIN R | MR | 781702050 |

P.PWD 300/15 cm

| Typ oceli Steel grade Stahlsorte Тип стали | Otevirání Opening Türöffnung Открытие | Sklo Glass Glas Стекло | Kód Code Code Код |
|---|--|---------------------------------|----------------------------|
| GR | DIN R | WH | 781702051 |
| GR | DIN R | BL | 781702052 |
| GR | DIN R | GR | 781702053 |
| GR | DIN R | STWH | 781702054 |
| GR | DIN R | STBL | 781702055 |
| GR | DIN R | STLT | 781702056 |

P.PWD 600/10 cm

| Typ oceli Steel grade Stahlsorte Тип стали | Otevirání Opening Türöffnung Открытие | Sklo Glass Glas Стекло | Kód Code Code Код |
|---|--|---------------------------------|----------------------------|
| SB | DIN L | MR | 781801001 |
| SB | DIN L | WH | 781801002 |
| SB | DIN L | BL | 781801003 |
| SB | DIN L | GR | 781801004 |
| SB | DIN L | STWH | 781801005 |
| SB | DIN L | STBL | 781801006 |
| SB | DIN L | STLT | 781801007 |
| SB | DIN R | MR | 781801008 |
| SB | DIN R | WH | 781801009 |
| SB | DIN R | BL | 781801010 |
| SB | DIN R | GR | 781801011 |
| SB | DIN R | STWH | 781801012 |
| SB | DIN R | STBL | 781801013 |
| SB | DIN R | STLT | 781801014 |
| WH | DIN L | MR | 781801015 |
| WH | DIN L | WH | 781801016 |
| WH | DIN L | BL | 781801017 |
| WH | DIN L | GR | 781801018 |
| WH | DIN L | STWH | 781801019 |
| WH | DIN L | STBL | 781801020 |
| WH | DIN L | STLT | 781801021 |
| WH | DIN R | MR | 781801022 |
| WH | DIN R | WH | 781801023 |
| WH | DIN R | BL | 781801024 |
| WH | DIN R | GR | 781801025 |
| WH | DIN R | STWH | 781801026 |
| WH | DIN R | STBL | 781801027 |
| WH | DIN R | STLT | 781801028 |
| BL | DIN L | MR | 781801029 |
| BL | DIN L | WH | 781801030 |
| BL | DIN L | BL | 781801031 |
| BL | DIN L | GR | 781801032 |
| BL | DIN L | STWH | 781801033 |
| BL | DIN L | STBL | 781801034 |
| BL | DIN L | STLT | 781801035 |
| BL | DIN R | MR | 781801036 |
| BL | DIN R | WH | 781801037 |
| BL | DIN R | BL | 781801038 |
| BL | DIN R | GR | 781801039 |
| BL | DIN R | STWH | 781801040 |
| BL | DIN R | STBL | 781801041 |
| BL | DIN R | STLT | 781801042 |
| GR | DIN L | MR | 781801043 |
| GR | DIN L | WH | 781801044 |
| GR | DIN L | BL | 781801045 |
| GR | DIN L | GR | 781801046 |
| GR | DIN L | STWH | 781801047 |
| GR | DIN L | STBL | 781801048 |
| GR | DIN L | STLT | 781801049 |
| GR | DIN R | MR | 781801050 |
| GR | DIN R | WH | 781801051 |
| GR | DIN R | BL | 781801052 |
| GR | DIN R | GR | 781801053 |
| GR | DIN R | STWH | 781801054 |
| GR | DIN R | STBL | 781801055 |
| GR | DIN R | STLT | 781801056 |

P.PWD 600/15 cm

| Typ oceli Steel grade Stahlsorte Тип стали | Otevirání Opening Türöffnung Открывание | Sklo Glass Glas Стекло | Kód Code Code Код |
|---|--|---------------------------------|----------------------------|
| SB | DIN L | MR | 781802001 |
| SB | DIN L | WH | 781802002 |
| SB | DIN L | BL | 781802003 |
| SB | DIN L | GR | 781802004 |
| SB | DIN L | STWH | 781802005 |
| SB | DIN L | STBL | 781802006 |
| SB | DIN L | STLT | 781802007 |
| SB | DIN R | MR | 781802008 |
| SB | DIN R | WH | 781802009 |
| SB | DIN R | BL | 781802010 |
| SB | DIN R | GR | 781802011 |
| SB | DIN R | STWH | 781802012 |
| SB | DIN R | STBL | 781802013 |
| SB | DIN R | STLT | 781802014 |
| WH | DIN L | MR | 781802015 |
| WH | DIN L | WH | 781802016 |
| WH | DIN L | BL | 781802017 |
| WH | DIN L | GR | 781802018 |
| WH | DIN L | STWH | 781802019 |
| WH | DIN L | STBL | 781802020 |
| WH | DIN L | STLT | 781802021 |
| WH | DIN R | MR | 781802022 |
| WH | DIN R | WH | 781802023 |
| WH | DIN R | BL | 781802024 |
| WH | DIN R | GR | 781802025 |
| WH | DIN R | STWH | 781802026 |
| WH | DIN R | STBL | 781802027 |
| WH | DIN R | STLT | 781802028 |
| BL | DIN L | MR | 781802029 |
| BL | DIN L | WH | 781802030 |
| BL | DIN L | BL | 781802031 |
| BL | DIN L | GR | 781802032 |
| BL | DIN L | STWH | 781802033 |
| BL | DIN L | STBL | 781802034 |
| BL | DIN L | STLT | 781802035 |
| BL | DIN R | MR | 781802036 |
| BL | DIN R | WH | 781802037 |
| BL | DIN R | BL | 781802038 |
| BL | DIN R | GR | 781802039 |
| BL | DIN R | STWH | 781802040 |
| BL | DIN R | STBL | 781802041 |
| BL | DIN R | STLT | 781802042 |
| GR | DIN L | MR | 781802043 |
| GR | DIN L | WH | 781802044 |
| GR | DIN L | BL | 781802045 |
| GR | DIN L | GR | 781802046 |
| GR | DIN L | STWH | 781802047 |
| GR | DIN L | STBL | 781802048 |
| GR | DIN L | STLT | 781802049 |
| GR | DIN R | MR | 781802050 |
| GR | DIN R | WH | 781802051 |
| GR | DIN R | BL | 781802052 |
| GR | DIN R | GR | 781802053 |
| GR | DIN R | STWH | 781802054 |
| GR | DIN R | STBL | 781802055 |
| GR | DIN R | STLT | 781802056 |

P.PWD 900/10 cm

| Typ oceli Steel grade Stahlsorte Тип стали | Otevirání Opening Türöffnung Открывание | Sklo Glass Glas Стекло | Kód Code Code Код |
|---|--|---------------------------------|----------------------------|
| SB | DIN L | MR | 781901001 |
| SB | DIN L | WH | 781901002 |
| SB | DIN L | BL | 781901003 |
| SB | DIN L | GR | 781901004 |
| SB | DIN L | STWH | 781901005 |
| SB | DIN L | STBL | 781901006 |
| SB | DIN L | STLT | 781901007 |
| SB | DIN R | MR | 781901008 |
| SB | DIN R | WH | 781901009 |

P.PWD 900/10 cm

| Typ oceli Steel grade Stahlsorte Тип стали | Otevirání Opening Türöffnung Открывание | Sklo Glass Glas Стекло | Kód Code Code Код |
|---|--|---------------------------------|----------------------------|
| SB | DIN R | BL | 781901010 |
| SB | DIN R | GR | 781901011 |
| SB | DIN R | STWH | 781901012 |
| SB | DIN R | STBL | 781901013 |
| SB | DIN R | STLT | 781901014 |
| WH | DIN L | MR | 781901015 |
| WH | DIN L | WH | 781901016 |
| WH | DIN L | BL | 781901017 |
| WH | DIN L | GR | 781901018 |
| WH | DIN L | STWH | 781901019 |
| WH | DIN L | STBL | 781901020 |
| WH | DIN L | STLT | 781901021 |
| WH | DIN R | MR | 781901022 |
| WH | DIN R | WH | 781901023 |
| WH | DIN R | BL | 781901024 |
| WH | DIN R | GR | 781901025 |
| WH | DIN R | STWH | 781901026 |
| WH | DIN R | STBL | 781901027 |
| WH | DIN R | STLT | 781901028 |
| BL | DIN L | MR | 781901029 |
| BL | DIN L | WH | 781901030 |
| BL | DIN L | BL | 781901031 |
| BL | DIN L | GR | 781901032 |
| BL | DIN L | STWH | 781901033 |
| BL | DIN L | STBL | 781901034 |
| BL | DIN L | STLT | 781901035 |
| BL | DIN R | MR | 781901036 |
| BL | DIN R | WH | 781901037 |
| BL | DIN R | BL | 781901038 |
| BL | DIN R | GR | 781901039 |
| BL | DIN R | STWH | 781901040 |
| BL | DIN R | STBL | 781901041 |
| BL | DIN R | STLT | 781901042 |
| GR | DIN L | MR | 781901043 |
| GR | DIN L | WH | 781901044 |
| GR | DIN L | BL | 781901045 |
| GR | DIN L | GR | 781901046 |
| GR | DIN L | STWH | 781901047 |
| GR | DIN L | STBL | 781901048 |
| GR | DIN L | STLT | 781901049 |
| GR | DIN R | MR | 781901050 |
| GR | DIN R | WH | 781901051 |
| GR | DIN R | BL | 781901052 |
| GR | DIN R | GR | 781901053 |
| GR | DIN R | STWH | 781901054 |
| GR | DIN R | STBL | 781901055 |
| GR | DIN R | STLT | 781901056 |

P.PWD 900/15 cm

| Typ oceli Steel grade Stahlsorte Тип стали | Otevirání Opening Türöffnung Открывание | Sklo Glass Glas Стекло | Kód Code Code Код |
|---|--|---------------------------------|----------------------------|
| SB | DIN L | MR | 781902001 |
| SB | DIN L | WH | 781902002 |
| SB | DIN L | BL | 781902003 |
| SB | DIN L | GR | 781902004 |
| SB | DIN L | STWH | 781902005 |
| SB | DIN L | STBL | 781902006 |
| SB | DIN L | STLT | 781902007 |
| SB | DIN R | MR | 781902008 |
| SB | DIN R | WH | 781902009 |
| SB | DIN R | BL | 781902010 |
| SB | DIN R | GR | 781902011 |
| SB | DIN R | STWH | 781902012 |
| SB | DIN R | STBL | 781902013 |
| SB | DIN R | STLT | 781902014 |
| WH | DIN L | MR | 781902015 |
| WH | DIN L | WH | 781902016 |
| WH | DIN L | BL | 781902017 |
| WH | DIN L | GR | 781902018 |
| WH | DIN L | STWH | 781902019 |

P.PWD 900/15 cm

| Typ oceli Steel grade Stahlsorte Тип стали | Otevirání Opening Türöffnung Открывание | Sklo Glass Glas Стекло | Kód Code Code Код |
|---|--|---------------------------------|----------------------------|
| WH | DIN L | STBL | 781902020 |
| WH | DIN L | STLT | 781902021 |
| WH | DIN R | MR | 781902022 |
| WH | DIN R | WH | 781902023 |
| WH | DIN R | BL | 781902024 |
| WH | DIN R | GR | 781902025 |
| WH | DIN R | STWH | 781902026 |
| WH | DIN R | STBL | 781902027 |
| WH | DIN R | STLT | 781902028 |
| BL | DIN L | MR | 781902029 |
| BL | DIN L | WH | 781902030 |
| BL | DIN L | BL | 781902031 |
| BL | DIN L | GR | 781902032 |
| BL | DIN L | STWH | 781902033 |
| BL | DIN L | STBL | 781902034 |
| BL | DIN L | STLT | 781902035 |
| BL | DIN R | MR | 781902036 |
| BL | DIN R | WH | 781902037 |
| BL | DIN R | BL | 781902038 |
| BL | DIN R | GR | 781902039 |
| BL | DIN R | STWH | 781902040 |
| BL | DIN R | STBL | 781902041 |
| BL | DIN R | STLT | 781902042 |
| GR | DIN L | MR | 781902043 |
| GR | DIN L | WH | 781902044 |
| GR | DIN L | BL | 781902045 |
| GR | DIN L | GR | 781902046 |
| GR | DIN L | STWH | 781902047 |
| GR | DIN L | STBL | 781902048 |
| GR | DIN L | STLT | 781902049 |
| GR | DIN R | MR | 781902050 |
| GR | DIN R | WH | 781902051 |
| GR | DIN R | BL | 781902052 |
| GR | DIN R | GR | 781902053 |
| GR | DIN R | STWH | 781902054 |
| GR | DIN R | STBL | 781902055 |
| GR | DIN R | STLT | 781902056 |

Montážní rám pro osazení modulu

Concealed mounting frame
 Unterputz Einbaurahmen
 Монтажная рама для установки модуля

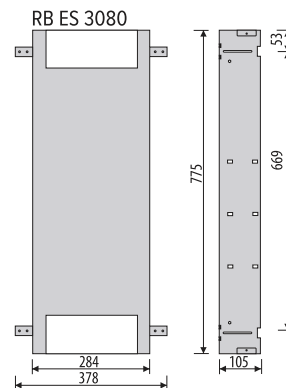
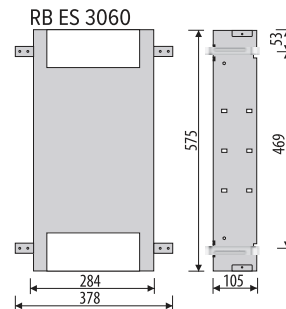
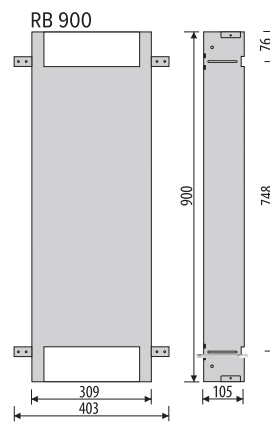
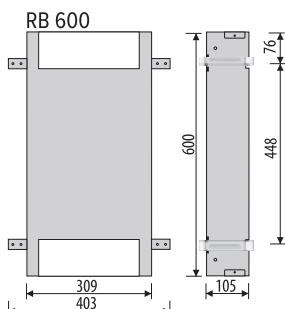
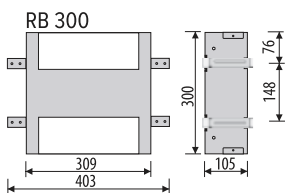

Montážní Rám
 Mounting Frame
 Einbaurahmen
 Монтажная рама

Kód
 Code
 Code
 Код

| | |
|------------|------------------|
| RB 300 | 789290101 |
| RB 600 | 789290102 |
| RB 900 | 789290103 |
| RB ES 3060 | 789290104 |
| RB ES 3080 | 789290105 |
| RBD 200 | 789290106 |
| RBD 300 | 789290107 |
| RBD 600 | 789290108 |
| RBD 900 | 789290109 |

Montage : VERTICAL/ HORIZONTAL

Montage : VERTICAL/ HORIZONTAL

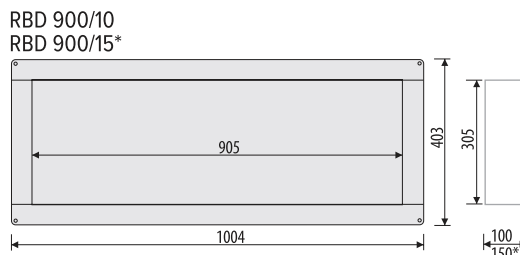
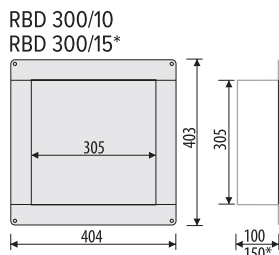
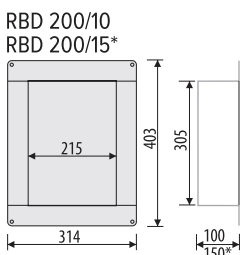

Typy skla

Types of glass doors
 Arten von Glastüren
 Виды стекла

Mirror

MR

White glossy

WH

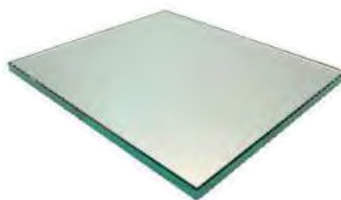

Grey glossy

GR

Black glossy

BL

White satin

ATWH



Latte satin

STLT

Black satin

STBL

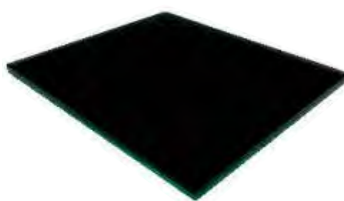
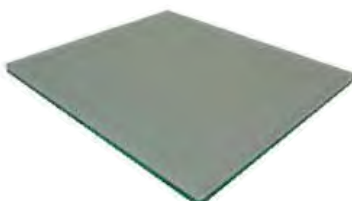

Katalogy Bemeta

Catalogues Bemeta
Bemeta Ergänzungskataloge
каталоги Bemeta

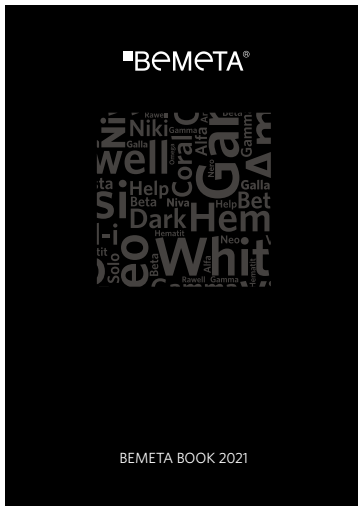

Změny produktů, cen, designu a informací vyhrazeny.
Informace a zobrazení odpovídají době vydání katalogu.
Za tiskové chyby neručíme.

Changes in products, prices, design and informations reserved.
Informations and images are corresponding to the time of the catalog
publication.

Änderungen an Produkten, Preisen, Design und Informationen vorbehalten.
Informationen und Ansichten entsprechen dem Zeitpunkt der Ausgabe vom
Katalog. Für Druckfehler tragen wir keine Verantwortung.

Производитель оставляет за собой право изменять дизайн и стоимость
продукции.
Вся указанная информация и фотографии продукции соответствуют
на дату выпуска каталога.

■ BEMETA

BEMETA DESIGN s. r. o.
Žatčany 28, 664 53, Czech Republic
tel.: +420 544 224 338, gsm: +420 739 201 806

www.bemeta.cz